

**Model DX2004/DX2008/DX2010/DX2020/
DX2030/DX2040/DX2048**

**Daqstation DX2000
Operation Guide**

Product Registration

Thank you for purchasing YOKOGAWA products.

YOKOGAWA provides registered users with a variety of information and services. Please allow us to serve you best by completing the product registration form accessible from our homepage.

<http://www.yokogawa.com/ns/reg/>

Contents

| | |
|---|-----------|
| Foreword..... | 3 |
| Safety Precautions..... | 3 |
| Handling Precautions of the DX..... | 4 |
| Handling Precautions of the External Storage Medium (CF Card)..... | 4 |
| Checking the Contents of the Package | 5 |
| Style number, release number, and firmware version number of the DX2000 | 6 |
| Protection of Environment | 6 |
| Conventions Used in This Manual..... | 7 |
| Opening the Electronic Manuals..... | 7 |
| Revision History..... | 7 |
| Introduction to Functions | 8 |
| Measured Items | 8 |
| Data Storage Function..... | 8 |
| Display Function | 8 |
| Other Functions | 8 |
| DAQSTANDARD..... | 8 |
| DX System Configuration | 9 |
| Terminology | 9 |
| Names of Parts | 10 |
| DX2000 Workflow | 12 |
| Turning the Power ON/OFF..... | 13 |
| Turning the Power ON | 13 |
| Turning the Power OFF | 13 |
| Basic Operation..... | 14 |
| Panel Keys..... | 14 |
| Display | 14 |
| Display on the Status Display Section | 15 |
| Run Modes | 16 |
| Entering Values and Characters | 17 |
| Changing the Date/Time | 18 |
| Operation Example in the Setting Mode: Changing the Input Range | 19 |
| Operation Example in the Basic Setting Mode: Changing the Scan Interval..... | 22 |
| ⚠ Inserting/Removing a CF Card | 24 |
| Saving the Setup Data..... | 26 |
| Loading the Setup Data | 27 |
| Setting the Input Range and Alarm..... | 28 |
| Setup Example 1: Temperature Measurement Channel..... | 28 |
| Setup Example 2: Flow Rate Measurement Channel and Alarm..... | 29 |
| Setting the Display | 30 |
| Setup Example 3: Assigning Channels to Groups | 30 |
| Setup Example 4: Setting the Time Scale | 31 |
| Setting the Data Storage..... | 32 |
| Setup Example 5: Continuously Record Measured Data and Automatically Save | 32 |
| Setup Example 6: Saving Measured Data at the Specified Time | 35 |
| Customizing the Operation..... | 36 |
| Setup Example 7: Assigning the Screen Image Data Storage Function to the USER key | 36 |
| Setup Example 8: Registering Frequently Used Screens to the Favorite Key | 37 |

Contents

| | |
|--|-----------|
| Operation | 39 |
| Starting the Memory Sample | 39 |
| Stopping the Memory Sample | 39 |
| Switching the Trend Display, Digital Display, and Bar Graph Display..... | 40 |
| Writing the Message "START" | 41 |
| Connecting to an Ethernet Network | 43 |
| Setup Example 9: Monitoring the DX on a PC Browser | 43 |
| Setup Example 10: Automatically Transferring the Measured Data File to an FTP Server | 46 |
| Using DAQSTANDARD | 48 |
| Displaying the Measured Data on DAQSTANDARD | 48 |
| Installation and Wiring | 49 |
| Installation Location | 49 |
| Installation Procedure | 50 |
| △ Input Signal Wiring..... | 52 |
| △ Optional Terminal Wiring..... | 55 |
| Alarm Output Terminal, FAIL Output Terminal, and Status Output Terminal (/A1, /A2, /A3, /A4, /A5, /F1, and /F2)..... | 61 |
| Remote Control Input Terminal (/R1) | 61 |
| Pulse Input Terminal (/PM1)..... | 61 |
| 24 VDC Transmitter Power Supply Output Terminal (/TPS4 and /TPS8)..... | 61 |
| Serial Interface..... | 61 |
| △ Connecting to the VGA Connector (/D5)..... | 62 |
| Connecting to the USB Port (/USB1)..... | 63 |
| Connecting to the Ethernet Port | 63 |
| △ Power Supply Wiring | 64 |
| Recommended Replacement Periods for Worn Parts Maintenance | 66 |
| Setup Items and Default Values | 67 |
| Setup Items in Setting Mode and Their Default Values | 68 |
| Setup Items in Basic Setting Mode and Their Default Values..... | 77 |

Daqstation DX2000 User's Manual (Electronic Manual Provided on the Accompanying CD)

| | |
|------------|---|
| Chapter 1 | Overview of Functions |
| Chapter 2 | Common Operations |
| Chapter 3 | Measurement Channels and Alarms |
| Chapter 4 | Switching Operation Screens |
| Chapter 5 | Operations for Changing the Displayed Contents |
| Chapter 6 | Saving and Loading Data |
| Chapter 7 | Customizing the Operation (Event Action) |
| Chapter 8 | Security Function |
| Chapter 9 | Computation and Report Functions (/M1 and /PM1 Options) |
| Chapter 10 | External Input Channels (/MC1 Option) |
| Chapter 11 | Troubleshooting |
| Chapter 12 | Maintenance |
| Chapter 13 | Specifications |

Daqstation DX1000/DX1000N/DX2000 Communication Interface User's Manual (Electronic Manual Provided on the Accompanying CD)

| | |
|-----------|------------------------------|
| Chapter 1 | Using the Ethernet Interface |
| Chapter 2 | Using the Serial Interface |
| Chapter 3 | Commands |
| Chapter 4 | Responses |
| Chapter 5 | Status Reports |
| Chapter 6 | Specifications |

Foreword

Thank you for purchasing the Daqstation DX2000 (DX). This manual describes the basic functions and operating procedures of the DX2000. To ensure correct use, please read this manual thoroughly before operation. The following five manuals are provided as DX2000 manuals.

Paper Manual

| Manual Title | Manual No. |
|---|-----------------|
| DX2000 Operation Guide | IM 04L42B01-02E |
| This manual. It is also provided in the CD. | |
| Control of Pollution Caused by the Product | IM 04L41B01-91C |
| Gives a description of pollution control. | |

Electronic Manuals Provided on the Accompanying CD

| Manual Title | Manual No. |
|--|-----------------|
| DX2000 Operation Guide | IM 04L42B01-02E |
| This is the electronic version of the paper manual. | |
| DX2000 User's Manual | IM 04L42B01-01E |
| Describes how to use the convenient functions of the DX2000. Communication function is excluded. | |
| DX1000/DX1000N/DX2000 Communication Interface User's Manual | IM 04L41B01-17E |
| Describes how to use the communication functions using the Ethernet and serial interfaces. | |
| DAQSTANDARD User's Manual | IM 04L41B01-61E |
| Describes how to use the accompanying software program, DAQSTANDARD. | |

Notes

- The contents of this manual are subject to change without prior notice as a result of continuing improvements to the instrument's performance and functions.
- Every effort has been made in the preparation of this manual to ensure the accuracy of its contents. However, should you have any questions or find any errors, please contact your nearest YOKOGAWA dealer.
- Copying or reproducing all or any part of the contents of this manual without YOKOGAWA's permission is strictly prohibited.
- The TCP/IP software of this product and the document concerning the TCP/IP software have been developed/created by YOKOGAWA based on the BSD Networking Software, Release 1 that has been licensed from the Regents of the University of California.

Trademarks

- vigilantplant, DAQSTATION, Daqstation, and DXAdvanced are registered trademarks of Yokogawa Electric Corporation.
- Microsoft and Windows are registered trademarks or trademarks of Microsoft Corporation in the United States and/or other countries.
- Adobe and Acrobat are registered trademarks or trademarks of Adobe Systems Incorporated.
- Company and product names that appear in this manual are registered trademarks or trademarks of their respective holders.
- The company and product names used in this manual are not accompanied by the registered trademark or trademark symbols (® and ™).

Revisions

| | |
|--------------|---------------|
| 1st Edition: | December 2005 |
| 2nd Edition: | October 2006 |
| 3rd Edition: | April 2007 |
| 4th Edition: | December 2007 |

4th Edition: December 2007 (YK)
All Rights Reserved, Copyright © 2005, Yokogawa Electric Corporation

Safety Precautions

This instrument conforms to IEC safety class I (provided with terminal for protective grounding), Installation Category II, and EN61326-1 (EMC standard), Measurement Category II (CAT II)*.

* Measurement category II (CAT II) applies to measuring circuits connected to low voltage installation, and electrical instruments supplied with power from fixed equipment such as electric switchboards.

This instrument is an EN61326-1 (EMC standard) class A instrument (for use in commercial, industrial, or business environments).

The general safety precautions described here must be observed during all phases of operation. If the DX is used in a manner not described in this manual, the DX safety features may be impaired. Yokogawa Electric Corporation assumes no liability for the customer's failure to comply with these requirements.

The DX is designed for indoor use.

About This Manual

- Please pass this manual to the end user. We also ask you to store this manual in a safe place.
- Read this manual thoroughly and have a clear understanding of the product before operation.
- This manual explains the functions of the product. It does not guarantee that the product will suit a particular purpose of the user.

Precautions Related to the Protection, Safety, and Alteration of the Product

The following safety symbols are used on the product and in this manual.



"Handle with care." To avoid injury and damage to the instrument, the operator must refer to the explanation in the manual.



Protective ground terminal



Functional ground terminal (do not use this terminal as a protective ground terminal.)



Alternating current



Direct current



ON (power)



OFF (power)

- For the protection and safe use of the product and the system in which this product is incorporated, be sure to follow the instructions and precautions on safety that are stated in this manual whenever you handle the product. Take special note that if you handle the product in a manner that violates these instructions, the protection functionality of the product may be damaged or impaired. In such cases, YOKOGAWA does not guarantee the quality, performance, function, and safety of product.
- When installing protection and/or safety circuits such as lightning protection devices and equipment for the product and control system or designing or installing separate protection and/or safety circuits for fool-proof design and fail-safe design of the processes and lines that use the product and the control system, the user should implement these using additional devices and equipment.
- If you are replacing parts or consumable items of the product, make sure to use parts specified by YOKOGAWA.
- This product is not designed or manufactured to be used in critical applications that directly affect or threaten human lives. Such applications include nuclear power equipment, devices using radioactivity, railway facilities, aviation equipment, air navigation facilities, aviation facilities, and medical equipment. If so used, it is the user's responsibility to include in the system additional equipment and devices that ensure personnel safety.
- Do not modify this product.

WARNING

- **Use the Correct Power Supply**
Ensure that the source voltage matches the voltage of the power supply before turning ON the power. In the case of a desktop type, ensure that it is within the maximum rated voltage range of the provided power cord before connecting the power cord.
- **Use the Correct Power Cord and Plug (Desktop Type)**
To prevent electric shock or fire, be sure to use the power cord supplied by YOKOGAWA. The main power plug must be plugged into an outlet with a protective earth terminal. Do not disable this protection by using an extension cord without protective earth grounding.
- **Connect the Protective Grounding Terminal**
Make sure to connect the protective grounding to prevent electric shock before turning ON the power.
The power cord that comes with the desktop type is a three-prong type power cord. Connect the power cord to a properly grounded three-prong outlet.
- **Do Not Impair the Protective Grounding**
Never cut off the internal or external protective grounding wire or disconnect the wiring of the protective grounding terminal. Doing so invalidates the protective functions of the instrument and poses a potential shock hazard.
- **Do Not Operate with Defective Protective Grounding**
Do not operate the instrument if the protective grounding might be defective. Also, make sure to check them before operation.
- **Do Not Operate in an Explosive Atmosphere**
Do not operate the instrument in the presence of flammable liquids or vapors. Operation in such an environment constitutes a safety hazard.
Prolonged use in a highly dense corrosive gas (H₂S, SO_x, etc.) will cause a malfunction.
- **Do Not Remove Covers**
The cover should be removed by YOKOGAWA's qualified personnel only. Opening the cover is dangerous, because some areas inside the instrument have high voltages.
- **Ground the Instrument before Making External Connections**
Connect the protective grounding before connecting to the item under measurement or control unit.
- **Damage to the Protection**
Operating the instrument in a manner not described in this manual may damage the instrument's protection.

CAUTION

This instrument is a Class A product. Operation of this instrument in a residential area may cause radio interference, in which case the user is required to take appropriate measures to correct the interference.

- **Exemption from Responsibility**
 - YOKOGAWA makes no warranties regarding the product except those stated in the WARRANTY that is provided separately.
 - YOKOGAWA assumes no liability to any party for any loss or damage, direct or indirect, caused by the user or any unpredictable defect of the product.
- **Handling Precautions of the Software**
 - YOKOGAWA makes no warranties regarding the software accompanying this product except those stated in the WARRANTY that is provided separately.
 - Use the software on a single PC.
 - You must purchase another copy of the software, if you are to use the software on another PC.
 - Copying the software for any purposes other than backup is strictly prohibited.
 - Please store the original media containing the software in a safe place.

- Reverse engineering, such as decompiling of the software, is strictly prohibited.
- No portion of the software supplied by YOKOGAWA may be transferred, exchanged, or sublet or leased for use by any third party without prior permission by YOKOGAWA.

Handling Precautions of the DX

- Use care when cleaning this instrument, especially its plastic parts. Use a soft dry cloth. Do not use organic solvents, such as benzene or thinner, or other cleansers. They may cause discoloring and deformation.
- Keep electrically charged objects away from the signal terminals. If you do, the DX may malfunction.
- Do not apply volatile chemicals to the display, panel keys, etc. Do not allow rubber and vinyl products to remain in contact with the DX for long periods of time. If you do, the DX may malfunction.
- When not in use, make sure to turn OFF the power switch.
- If there are any symptoms of trouble such as strange odors or smoke coming from the DX, immediately turn OFF the power switch and the power supply source. Then, contact your nearest YOKOGAWA dealer.

Handling Precautions of the External Storage Medium (CF Card)

- Use caution in the handling of the external storage medium as it is a delicate product.
- Write operation to storage media may fail under high-temperature or low-temperature environments. If you are using the DX in a low-temperature environment (around 10 °C or less), use the DX after the warm-up time (at least 30 minutes) has elapsed. If you are using the DX under a high-temperature environment (around 40 °C or more), it is recommended that the external storage medium be inserted into the drive when saving the data and be removed after the data storage operation is finished.
- Remove the storage medium from the drive when turning the DX ON/OFF.
- Touching the compact flash section when static electricity is built up on the human body can lead to erroneous operation.
- For the general handling precautions of the external storage medium, see the instruction manual that came with the external storage medium.

CAUTION

- Do not eject the external storage medium while the access indicator is illuminated. This can damage the data.
 - Do not access the storage medium in a place with vibrations or shock. The storage medium or drive may malfunction.
-

Checking the Contents of the Package

Unpack the box and check the contents before operating the instrument. If some of the contents are not correct or missing or if there is physical damage, contact the dealer from which you purchased them.

DX2000

A name plate is located on the top panel of the DX (side panel on models with the /H5[] option). Check that the model name and suffix code given on the name plate match those on your order.

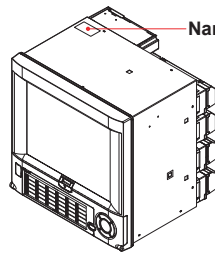

Name plate

| | |
|-----------|-------|
| MODEL | STYLE |
| SUFFIX | H S |
| SUPPLY | |
| FREQUENCY | |
| NO. | |

NO. (Instrument Number)

When contacting the dealer from which you purchased the instrument, please give them the instrument number.

MODEL and SUFFIX Code

| Model | Suffix Code | Optional code | Description |
|------------------------|-------------|---------------|---|
| DX2004 | | | Daqstation DX2000 4ch, 125 ms (Fast sampling mode 25 ms) |
| DX2008 | | | Daqstation DX2000 8ch, 125 ms (Fast sampling mode 25 ms) |
| DX2010 | | | Daqstation DX2000 10ch, 1 s (Fast sampling mode 125 ms) |
| DX2020 | | | Daqstation DX2000 20ch, 1 s (Fast sampling mode 125 ms) |
| DX2030 | | | Daqstation DX2000 30ch, 1 s (Fast sampling mode 125 ms) |
| DX2040 | | | Daqstation DX2000 40ch, 1 s (Fast sampling mode 125 ms) |
| DX2048 | | | Daqstation DX2000 48ch, 1 s (Fast sampling mode 125 ms) |
| Internal memory size | -1 | | Standard memory |
| | -2 | | Large memory |
| External storage media | -4 | | With CF card |
| Language | | -2 | English/German/French, deg F, and DST (English version of DAQSTANDARD included) |
| Options | | | |
| | /A1 | | Alarm output 2 points ¹ |
| | /A2 | | Alarm output 4 points ^{1,11} |
| | /A3 | | Alarm output 6 points ¹ |
| | /A4 | | Alarm output 12 points ^{1,11,11} |
| | /A5 | | Alarm output 24 points ^{1,11,11,11} |
| | /C2 | | RS-232 interface ³ |
| | /C3 | | RS-422/485 interface ³ |
| | /D5 | | VGA output |
| | /F1 | | FAIL/status output ^{2,4,9} |
| | /F2 | | FAIL + alarm output 22 points ^{1,4,11} |
| | /H2 | | Clamped input terminal (detachable) |
| | /H5[] | | Desktop type ⁵ |
| | /M1 | | Mathematical functions (including the report function) ¹¹ |
| | /N1 | | Cu10, Cu25 RTD input/3 leg isolated RTD |
| | /N2 | | 3 leg isolated RTD ⁸ |
| | /N3 | | Extended input type (PR40-20, Pt50, etc.) |
| | /P1 | | 24 VDC/AC power supply ⁹ |
| | /R1 | | Remote control ¹¹ |
| | /TPS4 | | 24-VDC transmitter power supply (4 loops) ⁷ |
| | /TPS8 | | 24-VDC transmitter power supply (8 loops) ^{7,11} |
| | /KB1 | | Easy Text Entry (with input terminal) ^{9,10} |
| | /KB2 | | Easy Text Entry (without input terminal) ⁹ |
| | /USB1 | | USB interface |
| | /PM1 | | Pulse input (including remote control and mathematical function) ¹¹ |
| | /CC1 | | Calibration correction function |
| | /MC1 | | External input function ¹² |

¹ /A1, /A2, /A3, /A4, /A5, and /F2 cannot be specified simultaneously.

² /A5 and /F1 cannot be specified simultaneously.

³ /C2 and /C3 cannot be specified simultaneously.

⁴ /F1 and /F2 cannot be specified simultaneously.

⁵ /H5[]

| | |
|------------|---|
| D: | Power cord UL, CSA st'd |
| F: | Power cord VDE st'd |
| R: | Power cord SAA st'd |
| J: | Power cord BS st'd |
| H: | Power cord GB st'd |
| Null (H5): | Only for /P1 model (without power cord) |

⁶ /N2 can be specified only for DX2010, DX2020, DX2030, DX2040 and DX2048.

⁷ /TPS4, /TPS8, /A5 and /F2 cannot be specified simultaneously.

⁸ If /TPS8 is specified, /A4 and /F1 cannot be specified simultaneously.

⁹ /KB1 and /KB2 cannot be specified simultaneously.

¹⁰ If /KB1 is specified, a remote control terminal (438227) is included.

¹¹ If /PM1 is specified, /A5, /F2, /M1, and /R1 cannot be specified simultaneously.

The combination of /A2/F1 and the combination of /A4/TPS8 cannot be specified simultaneously.

¹² /MC1 can be specified only for DX2010, DX2020, DX2030, DX2040 and DX2048.

Standard Accessories

The standard accessories below are supplied with the instrument. Check that all contents are present and undamaged.

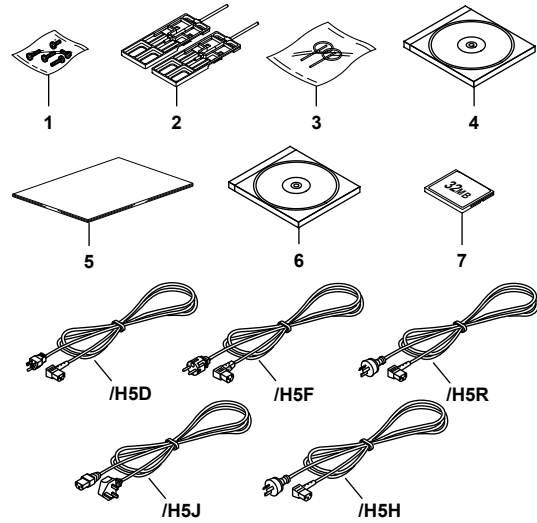

8. One of these power cord types is supplied according to the instrument's suffix code

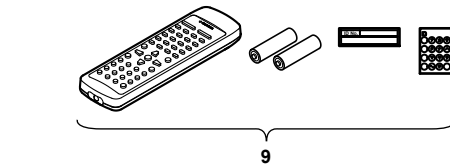

| No. | Name | Part Number/ Model | Qty. | Notes |
|-----|---|--------------------|------|---|
| 1 | Terminal screws | E9655FX | 5 | M4 (spares) |
| 2 | Mounting brackets | B9900BX | 2 | For panel mounting Except for the /H5[] models. |
| 3 | Door lock key | B8706FX | 2 | — |
| 4 | DAQSTANDARD for DXAdvanced | DXA120 | 1 | CD. Software for setting the DX and displaying data. |
| 5 | DX2000 Operation Guide (this manual) | IM 04L42B01-02E | 1 | A4 size |
| | Control of Pollution Caused by the Product | IM 04L41B01-91C | 1 | |
| 6 | User's Manuals for the DX1000/ DX1000N/DX2000 | B8706ZZ | 1 | CD. Contains the PDF file of the user's manual. |
| 7 | CF card | B9968NM | 1 | 32 MB (The size and model may change.) |
| 8 | Power cord | A1006WD | 1 | Supplied only for models with the /H5D option. Maximum rated voltage: 125 V |
| | | A1024WD | 1 | Supplied only for models with the /H5R option. Maximum rated voltage: 250 V |
| | | A1054WD | 1 | Supplied only for models with the /H5J option. Maximum rated voltage: 250 V |
| | | A1064WD | 1 | Supplied only for models with the /H5H option. Maximum rated voltage: 250 V |

| No. | Name | Part Number/ Model | Qty. | Notes |
|-----|-------------------------|-----------------------|------|--|
| 9 | Remote control terminal | 438227 | 1 | Remote controller. Supplied only for models with the /KB1 option. With two AA alkaline batteries and labels for the remote control terminal. |

Optional Accessories (Sold Separately)

The following optional accessories are available for purchase separately. If you make an order, make sure that all contents are present and undamaged. For information about ordering accessories, contact the dealer from which you purchased the DX.

| No. | Name | Model | Minimum Q'ty | Notes |
|-----|---|---------|--------------|--------------------|
| 1 | CF card | 772091 | 1 | 128 MB |
| | | 772092 | 1 | 256 MB |
| | | 772093 | 1 | 512 MB |
| | | 772094 | 1 | 1 GB |
| 2 | CF card adapter | 772090 | 1 | – |
| 3 | Shunt resistor (for screw input terminal) | 415920 | 1 | 250 Ω ± 0.1% |
| | | 415921 | 1 | 100 Ω ± 0.1% |
| | | 415922 | 1 | 10 Ω ± 0.1% |
| 4 | Shunt resistor (for clamped input terminal) | 438920 | 1 | 250 Ω ± 0.1% |
| | | 438921 | 1 | 100 Ω ± 0.1% |
| | | 438922 | 1 | 10 Ω ± 0.1% |
| 5 | Mounting brackets | B9900BX | 2 | – |
| 6 | Door lock key | B8706FX | 1 | – |
| 7 | Remote control terminal | 438227 | 1 | Remote controller. |

Style number, release number, and firmware version number of the DX2000

Style number: This is the DX2000 hardware number that is indicated on the name plate.

Release number: This is the DX2000 firmware number that is indicated on the name plate. The number corresponds to the integer part of the firmware version number.

Example: If the firmware version number is 2.01, the release number is 2.

Firmware version number: This number is displayed on the DX2000 system information screen. For the procedure, see section 2.5, "Viewing the DX Information" in the DX2000 User's Manual (IM 04L42B01-01E).

| MODEL | STYLE | |
|-----------|-------|---|
| | H | S |
| | 2 | 2 |
| SUFFIX | | |
| SUPPLY | | |
| FREQUENCY | | |
| NO. | | |

Release number
Style number

Protection of Environment

Control of Pollution Caused by the Product



For details, see the *Control of Pollution Caused by the Product* (IM04L41B01-91C).

Proper Disposal of This Product

This is an explanation of how to dispose of this product based on Waste Electrical and Electronic Equipment (WEEE), Directive 2002/96/EC. This directive is only valid in the EU.

- **Marking**

This product complies with the WEEE Directive (2002/96/EC) marking requirement.

The affixed product label (see below) indicates that you must not discard this electrical/electronic product in domestic household waste.



- **Product Category**

With reference to the equipment types in the WEEE directive Annex 1, this product is classified as a "Monitoring and Control instrumentation" product.

Do not dispose in domestic household waste.

To return unwanted products, contact your local Yokogawa Europe B. V. office.

Conventions Used in This Manual

- This manual covers information regarding DX2000s that have a suffix code for language "-2" (English).
- For details on how to set the language, see section 2.6, "Changing the Language" in the *DX2000 User's Manual (IM 04L42B01-01E)*.

Unit

K: Denotes 1024. Example: 768 KB (file size)

k: Denotes 1000.

The following markings are used in this manual.



Improper handling or use can lead to injury to the user or damage to the instrument. This symbol appears on the instrument to indicate that the user must refer to the user's manual for special instructions. The same symbol appears in the corresponding place in the user's manual to identify those instructions. In the manual, the symbol is used in conjunction with the word "WARNING" or "CAUTION."

WARNING

Calls attention to actions or conditions that could cause serious or fatal injury to the user, and precautions that can be taken to prevent such occurrences.

CAUTION

Calls attentions to actions or conditions that could cause light injury to the user or damage to the instrument or user's data, and precautions that can be taken to prevent such occurrences.

Note

Calls attention to information that is important for proper operation of the instrument.



Indicates after this mark reference to related procedure or explanation.

Bold characters

Indicates character strings that appear on the screen and the operation keys.

Opening the Electronic Manuals

The accompanying CD contains PDF files of the manuals. When you load the CD into the CD-ROM drive on your PC, a startup screen appears. Click the manual title to open the respective manual.

If the startup screen does not appear, double-click DX_manual in My Computer, and open the manuals in the English directory.

Revision History

The contents of this manual corresponds to the DX with release number 2 and style number 2.

| Edition | DX | Addition and change to functions |
|---------|---------------------------------|--|
| 2 | Version 1.11 | German, French, and Chinese can be selected as display language. Modbus client: 10 s, 20 s, and 30 s have been added to the choices for the connection retry interval. 24 VDC/AC power supply (/P1 option) have been added. |
| | Version 1.21 | Tab key on the USB keyboard corresponds to arrow keys (/USB1 option). Operations to request and release network information are added. Modbus client: Function to connect a server with a unit number is changed. Modbus client: Connection timeout value is changed. Modbus registers (floating point type for communication input data) are added. A data output format (Skip or OFF channel data not output) is added. Error messages 105, 221, and 222 are added. Error messages 215, 218, 536 and 536 are changed. |
| 3 | Release number 2 (Version 2.0x) | Improvement to the operability on the historical trend display. |
| | | Displaying the date in the grid time of the trend display If the trend interval is set greater than or equal to 1 h/div. |
| | | Improvement to the display group setup operation. |
| | | Addition of the Upper and Lower settings to the bar graph base position. |
| | | Relay action when the alarm ACK operation is executed has been added to the alarm output relay settings. |
| | | Ability to reset the computed value during computation (/M1 and /PM1 options). |
| | | Changes to how the data files are named. |
| | | Sorting the files by the update date/time. |
| | | Storage method for constantly retaining the most recent data files in the CF card (Media FIFO). |
| | | Progress display when saving all data of the internal memory. |
| | | Changing the initial display selection menu. |
| | | Improvement to the data save operation to the USB flash memory (/USB1 option). |
| | | Retaining the state of the CapsLock and NumLock keys on the USB keyboard (/USB1 option). |
| | | Function for automatically assigning MW100s to the Modbus client. |
| | | Changing the default setting of the web server function to "Use." |
| | | Error messages, 129, 131, 132, 133, 134, 135, 136, 137, 513, 514, 515, and 516 have been added. |
| | | Style number 2 |
| 4 | Same as edition 3 | Added explanations. Fixed explanations. |

Introduction to Functions

Measured Items

You can connect DC voltage, thermocouple, RTD, and ON/OFF input and measure various values such as temperature and flow rate. The DX samples the input signals at the scan interval to obtain the measured values. The fastest scan interval is 25 ms on the DX2004 and DX2008 and 125 ms on the DX2010, DX2020, DX2030, DX2040, and DX2048.

Up to four alarm conditions can be set for each measurement channel.

Data Storage Function

There are two methods of recording measured data. One is to record the measured data continuously, and the other is to record only when certain events occur such as alarms. The measured data is recorded to the internal memory at a specified interval. The data in the internal memory can be stored to a CF card automatically or manually. By connecting to a network via the Ethernet interface, the measured data can also be automatically transferred to an FTP server on a network.

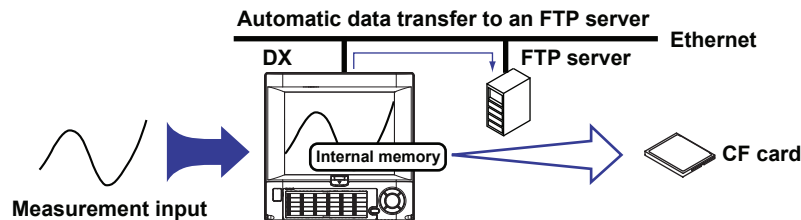

Display Function

Measured data can be displayed as trends, numeric values, and bar graphs for each group. In addition, the overview display can be used to display and monitor all channels on a single screen.

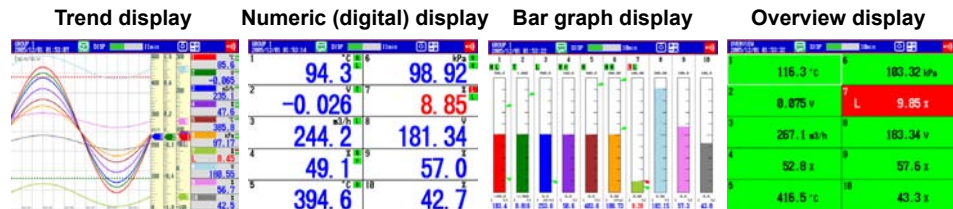

Other Functions

| | |
|---|--|
| Computation Function (option) | Various types of computation can be performed by assigning equations to computation channels. |
| FAIL/status output function (option) | Outputs an alarm when the DX fails. The function also monitors the DX status such as the remaining amount of internal memory and outputs alarms. |
| Remote control function (option) | A specified action is executed when a remote input signal is applied to the terminal on the rear panel. |
| Security function | Enables only registered users can operate the DX. The function can also be used to prohibit key operation. |
| Communication function | The Ethernet interface can be used to monitor the DX using a Web browser and transmit e-mail when an event occurs such as an alarm. In addition, data of devices on the network can be loaded and displayed using the Modbus protocol. |

DAQSTANDARD

The accompanying software program, DAQSTANDARD, can be used to display the measured data, convert the measured data format, and create DX setup data.

DX System Configuration

The DX can be used to configure a system as shown below.

Referenced sections are of the *DX2000 User's Manual*.

Referenced pages are of this manual.

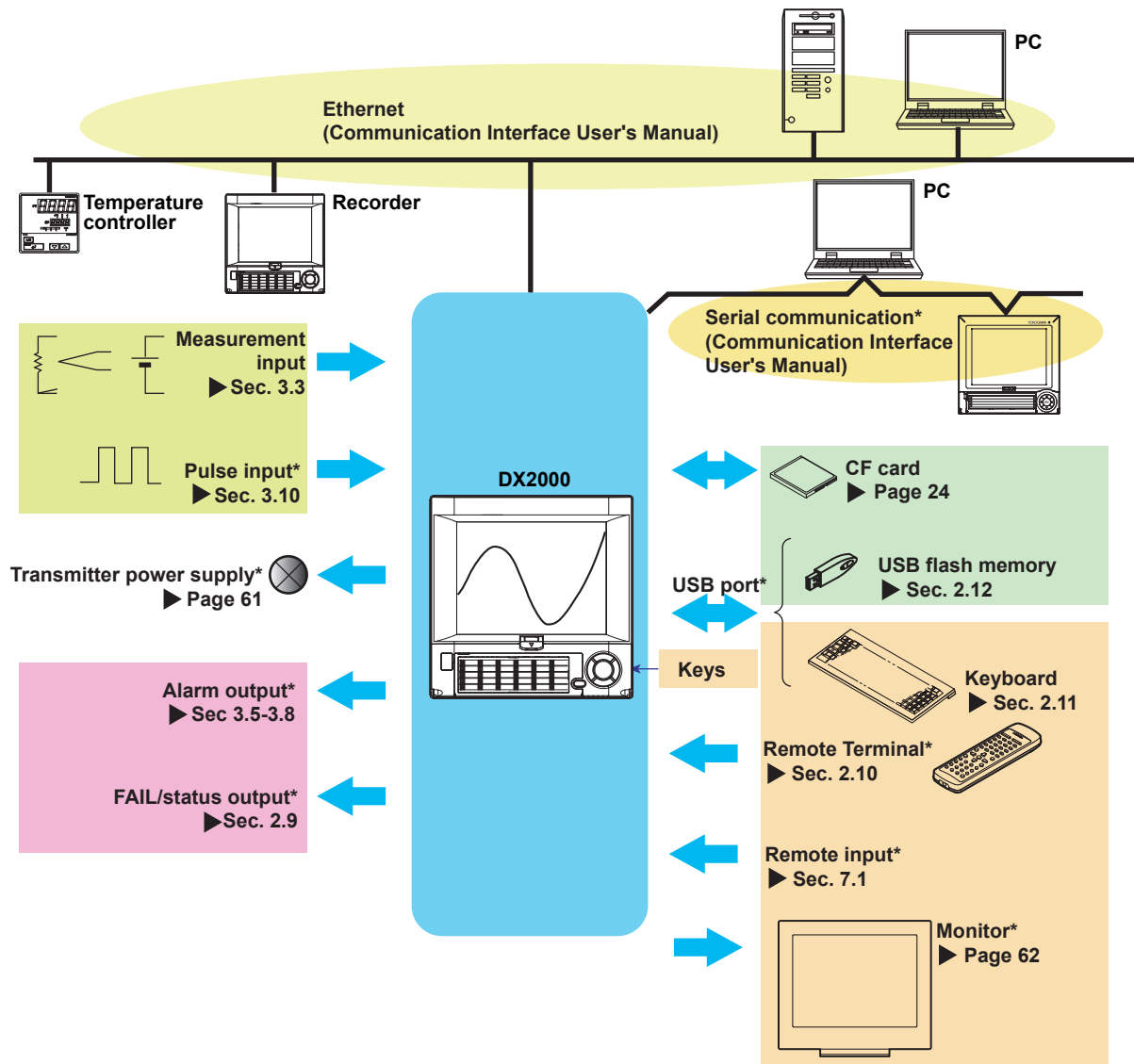

*: Option

Terminology

- **Memory sample**
The operation of recording measured data.
- **Memory start**
The operation of starting the memory sample.
- **Memory stop**
The operation of stopping the memory sample.
- **Display data**
The waveform data shown on the DX display. The data recorded at the sampling interval for the displayed data.
- **Event data**
Measured data recorded at a sampling interval separate from that of the display data.

Names of Parts

Front View

Key panel opened

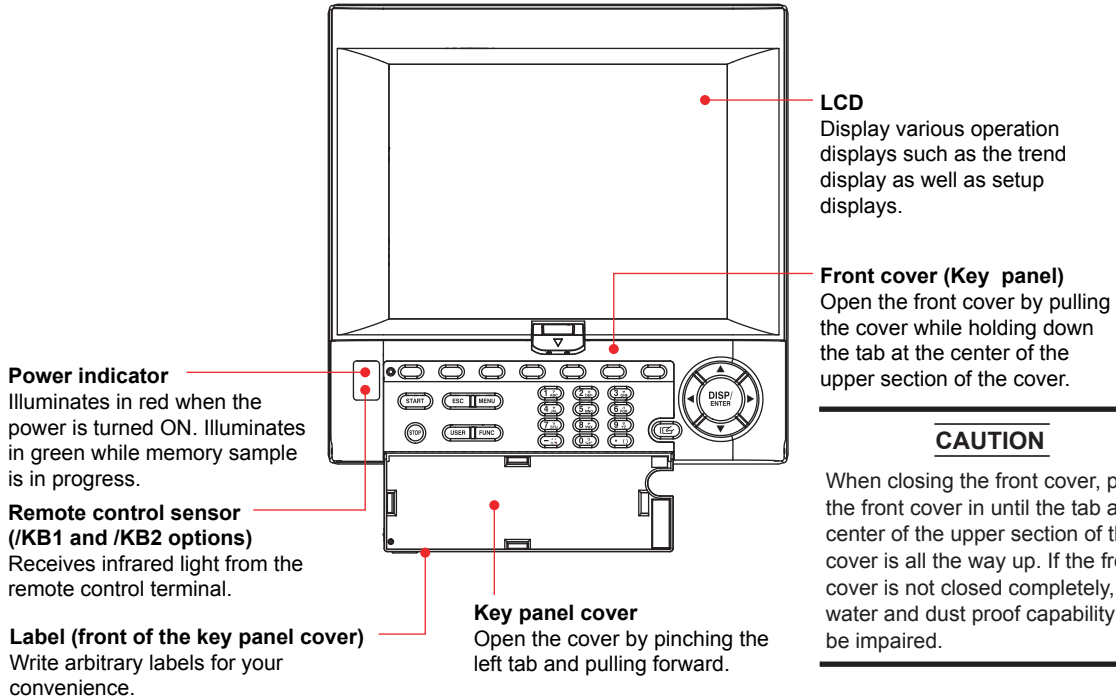

CAUTION

When closing the front cover, press the front cover in until the tab at the center of the upper section of the cover is all the way up. If the front cover is not closed completely, the water and dust proof capability may be impaired.

Front cover opened

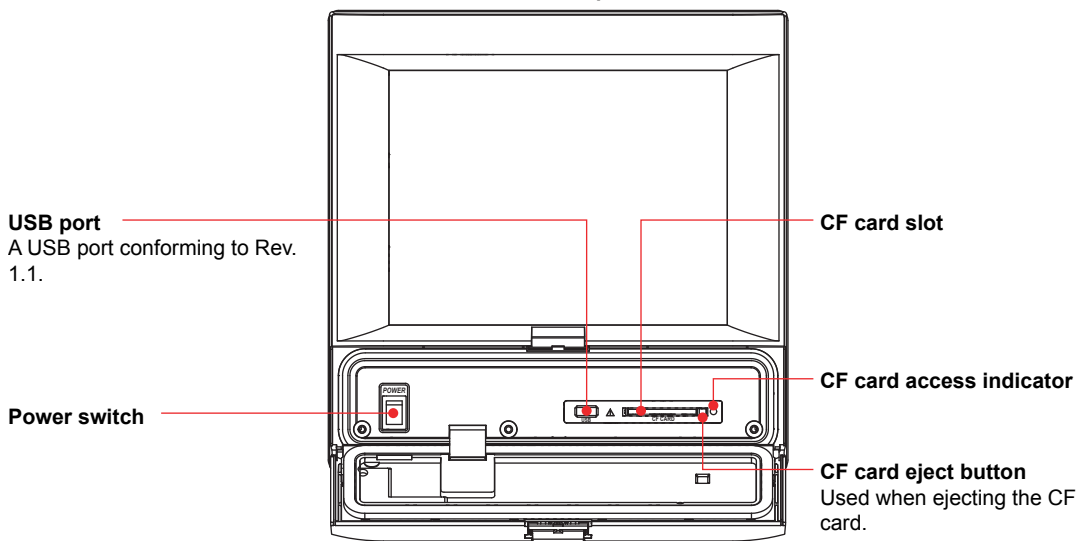

Door lock key (included)

Insert the pin in the left hole to lock.
Insert the pin in the right hole to unlock.

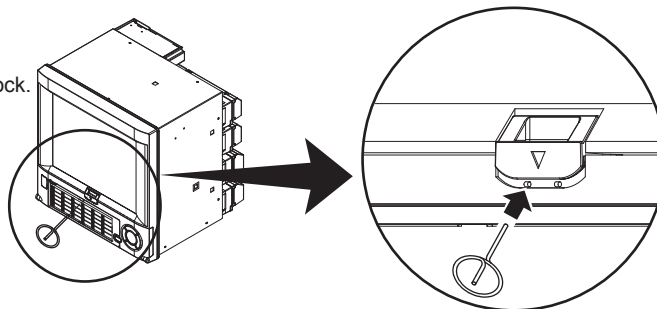

Rear Panel

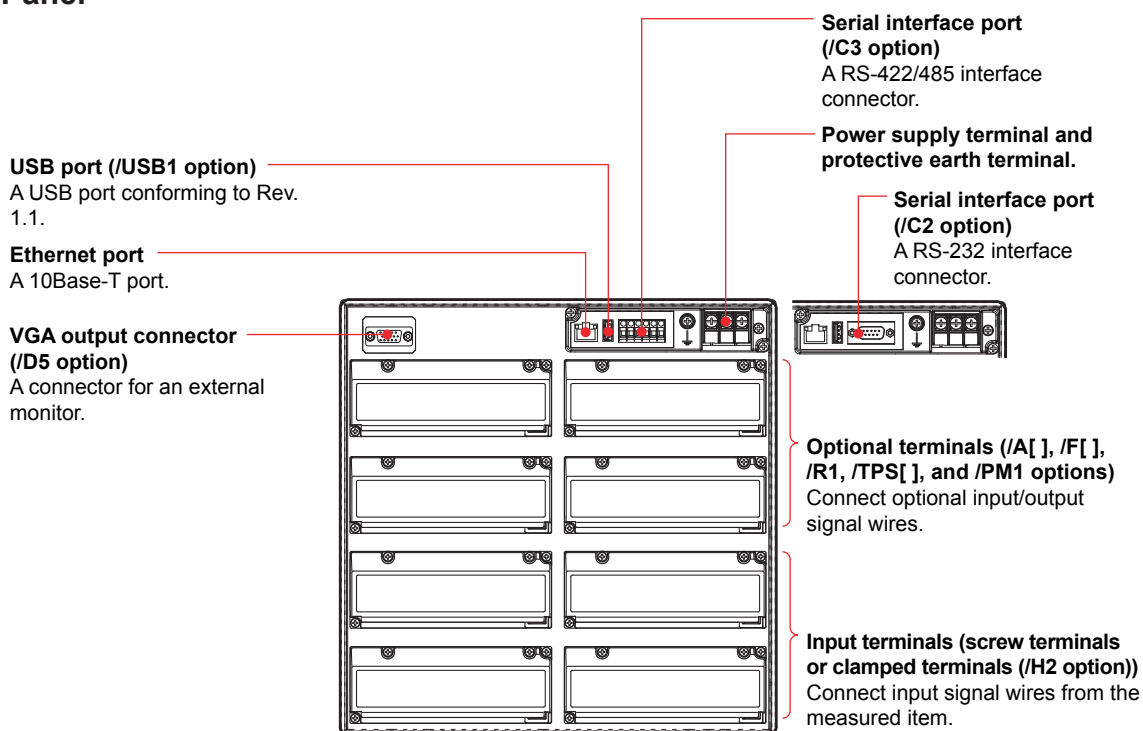

Desktop Type (/H5[] Option)

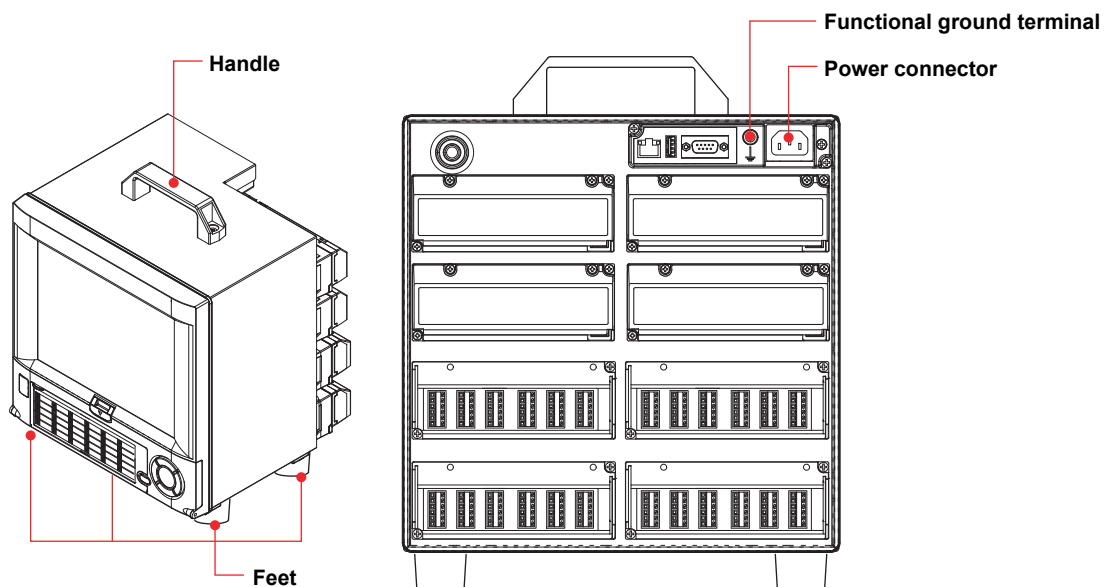

DX2000 Workflow

When using the DX for the first time, carry out the following procedure.

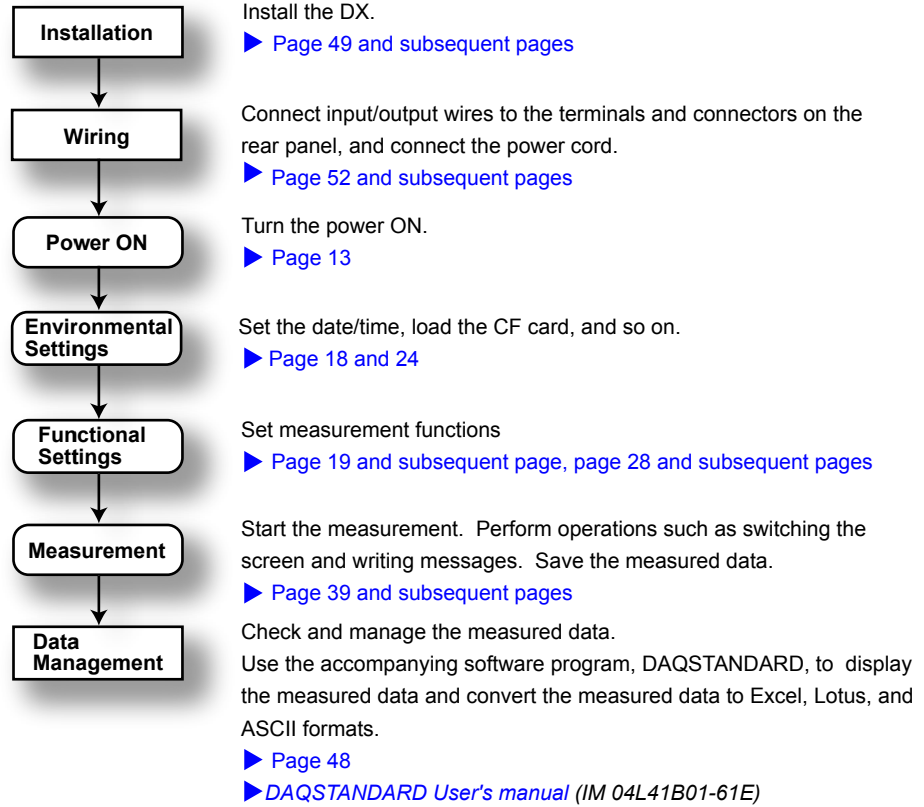

Turning the Power ON/OFF

Turning the Power ON



CAUTION

Before turning ON the power switch, check that

- The power cord/wires are connected correctly to the DX.
- The DX is connected to the correct power supply (see page 64).

If the input wires are connected in parallel with other devices, do not turn ON/OFF the power switch of the DX or another device during operation. This can have adverse effects on the measured values.

1. Open the operation cover.
2. Turn ON the power switch.

After performing a self-test for a few seconds, the operation screen appears.

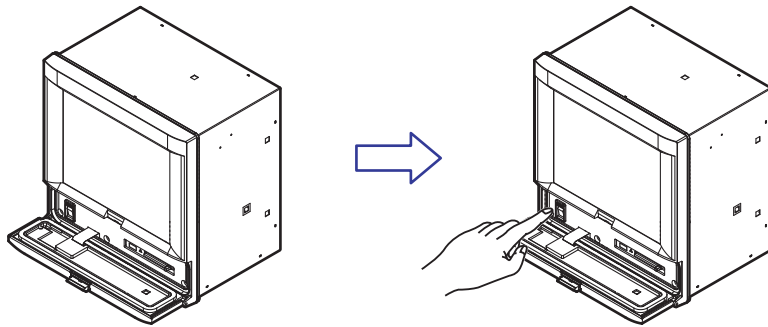

3. Close the operation cover.



CAUTION

- If nothing is displayed when the power switch is turned ON, turn OFF the power switch and check the points listed above one more time. After checking the points, turn ON the power switch again. If the DX still does not work, it is probably a malfunction. Contact your nearest YOKOGAWA dealer for repairs.
- If an error message is displayed on the screen, take measures according to the description in chapter 11, "Troubleshooting" in the *DX2000 User's Manual*.
- Turn ON the power switch, let the DX warm up for at least 30 minutes, and then start the measurements.

Turning the Power OFF



CAUTION

Before turning OFF the power switch, check that the external storage medium is not being accessed.

1. Open the operation cover.
2. Turn OFF the power switch.
3. Close the operation cover.

Basic Operation

Panel Keys

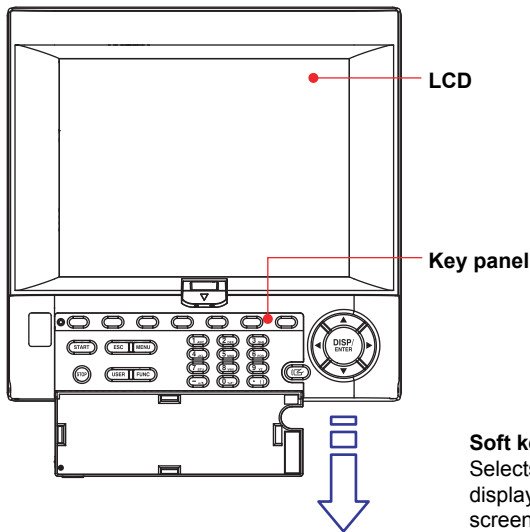

START/STOP key
Memory start/stop

ESC key
Cancels an operation

USER key
Executes the assigned operation

Soft keys
Selects the menu that is displayed at the bottom of the screen

Character/Number input keys
Enters characters and numbers

MENU key
Switches between the operation mode and setting mode

FUNC key

- Displays the soft key menu in operation mode
- Hold down this key at least 3 s in the setting mode to switch from the setting mode to the basic setting mode

DISP/ENTER key and four arrow keys (up, down, left, and right)
Switches the operation screen. Selects and enters setup items.

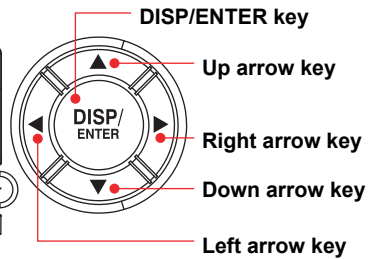

DISP/ENTER key

Up arrow key

Right arrow key

Down arrow key

Left arrow key

Favorite key
Displays the operation screen (up to eight screens) that are registered to the key

Display

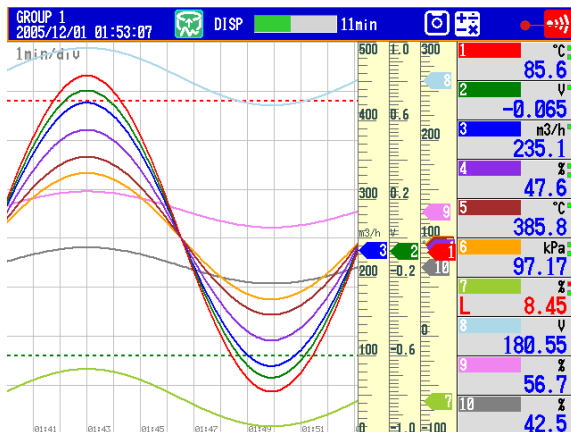

Status display section
Shows the display name, date/time, data recording, alarm icon, etc.

Data display section
Shows the measured data and the functional setup display.

Display on the Status Display Section

The following information is displayed in the status display section.

Memory sample status

| | | |
|----------------------------------|--|--|
| Memory sample stopped | | Data type DISP: Display data EVENT: Event data |
| Memory sample in progress | | Memory sample progress Displays the progress using a green bar graph. The frame indicates the file save interval (display data) or the data length (event data). |
| Memory sample icon | | <p>Displays the remaining memory sample time for the left bar graph.</p> <p>Error in internal memory. Contact your nearest YOKOGAWA dealer for repairs.</p> |

GROUP 1 ALL DISP 46min

2005/09/22 10:57:53

Display name or group name
For all channel display on the trend display, "ALL" is displayed.

Date and time
Displayed in yellow while the time is being corrected.

When using the batch function

P1-process-000003
2005/09/22 10:57:47

Batch name (shown alternately with the display name)
Date and time

If the "batch number-lot number" exceeds 20 characters, the "date and time" position is used to display the "batch number-lot number."

When using the login function

Admin1
GROUP 1 ALL
2005/09/22 11:03:40

Name of the user logged in
Display name
Date and time

When using the login and batch functions

Admin1
P1-process-000004
2005/09/22 11:03:47

Name of the user logged in
Batch name (shown alternately with the display name)
Date and time

Alarm icon

(Red) Displayed when any alarm is activated. Blinks when there are alarms that are occurring but have not been acknowledged.

(Green) All alarms have been released after they have occurred, but there are alarms that have not been acknowledged.

Status icon

The status assigned to the status output relay (/F1 option) is occurring.

Keys are locked.

E-mail transmission is enabled.

Computation icon (/M1 or /PM1 option)

White icon: Computation in progress

Yellow icon: Computation dropout occurred

CF card icon

CF card is being accessed.

Waiting.

Light blue icon: CF card in the slot is not recognized. Remove and reset it.

CF card error.
Carry out the procedure below to reset the CF card icon to normal.

- Remove the CF card, and then reinsert it.
- Replace the CF card with a normal one.
- Format the CF card on the DX (the data on the CF card will be erased).

The green level display indicates the amount of CF card used. If Media FIFO* is not enabled and the free space on the CF card falls below 10%, the level indicator changes to red.

* See section 1.4, in the DX1000/DX1000N User's Manual. Media FIFO is a function available on release number 2 or later.

Run Modes

Mode Transition Diagram

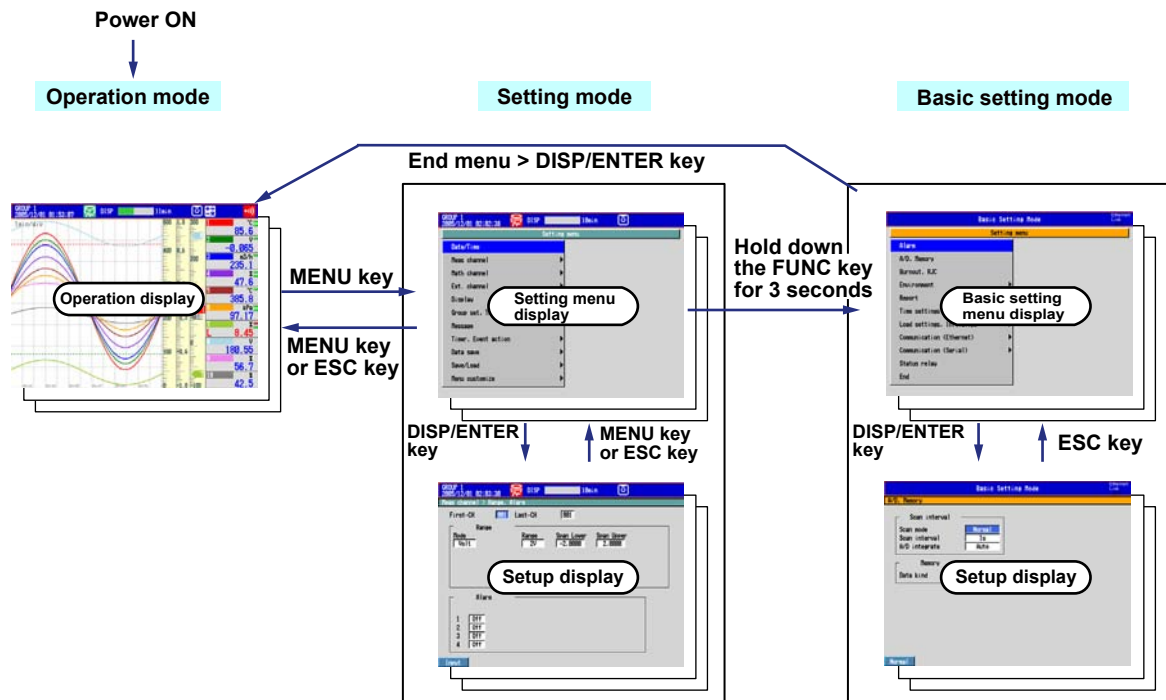

The DX has three modes.

| Mode | Description |
|--------------------|---|
| Operation mode | A mode for performing measurements. |
| Setting mode | A mode in which input range, measurement method, and so on are configured. Settings can be changed when memory sample is in progress excluding some items. |
| Basic setting mode | A mode used to set basic items such as the scan interval and storage format of measured data. You cannot switch to this mode when memory sample is in progress. |

* For further details on the basic setting mode and setting mode, see page 67.

Carry out the steps given in the following pages. It will help you to understand the DX operation.

Entering Values and Characters

The character/number input keys and DISP/ENTER key are used to set the date/time, set the display span of the input range, set the tag, set the message string, enter the password, etc.

Character/Number input keys

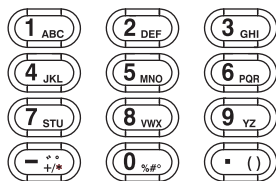

DISP/ENTER key and four arrow keys (up, down, left, and right)

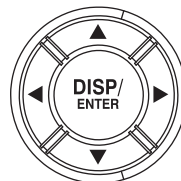

Entering Values

When a window for entering a value appears, enter the value by performing the following key operation.

- **Left and right arrow keys:** Selects the input position.
- **Character/Number input keys:** Enters a value.

The following soft key appears when it can be used.



- **Space soft key:** Enters a space.

Entering Character Strings

When a window for entering a character string appears, enter it by performing the following key operation.

- **Left and right arrow keys:** Selects the input position.
- **Character/Number input keys:** Enters a character string.

The character to be entered is determined by the number of times the character type key and the character/number input key is pressed. The character types that can be entered vary depending on the item being set.



Input status of the A/a/1 soft key

Input status of the Ins soft key

- **Space soft key:** Enters a space.
- **Del soft key:** Deletes the character at the cursor.
- **Bs soft key:** Deletes the character before the cursor.
- **Ins soft key:** Selects insert or overwrite.
Insert and overwrite mode toggles each time the Ins soft key is pressed. The selected mode is shown on the right side of the soft key display section.
- **A/a/1 soft key:** Selects uppercase alphabet (A), lowercase alphabet (a), or value (1).
The character type that you can enter changes each time you press the A/a/1 soft key. The selected character type is shown on the right side of the soft key display section.

Changing the Date/Time

In this example, we will change the date to the 14th. After carrying out this step, reset the time to the correct date/time.

1. Display the operation mode screen.

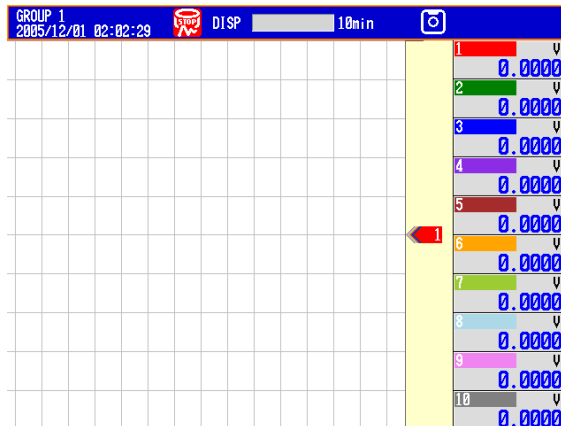

2. Press **MENU** once to display the setting menu.

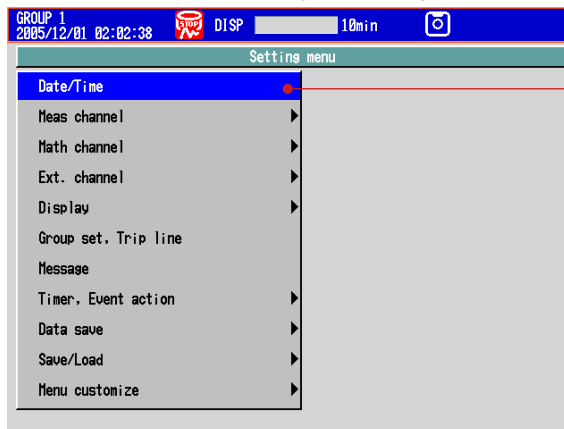

Select Date/Time

3. Press **DISP/ENTER** once to open the Time set window.
4. Set the date to 14.

Select the input position: **Left and right arrow keys**
 Change the value: **Character/Number input keys**
 Enter the input: **DISP/ENTER**
 Cancel the setting: **Press ESC before pressing DISP/ENTER.**

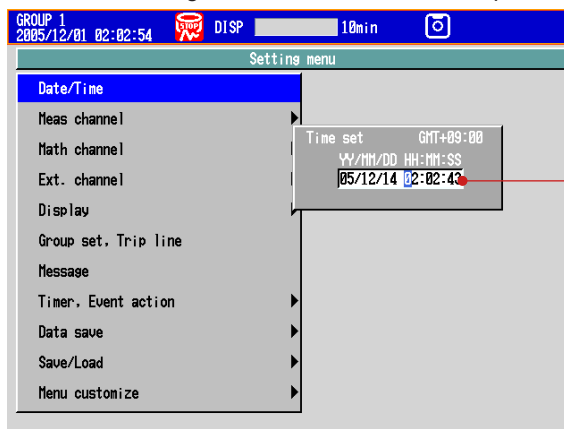

Display the Time set window

5. Press **ESC** or **MENU** once to return to the operation mode screen.
 Operation complete.

Operation Example in the Setting Mode: Changing the Input Range

Set the input range of channel 2 to thermocouple type T and 0.0 to 400.0°C.

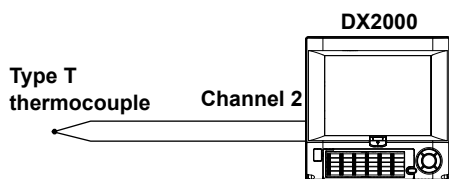

1. Display the operation mode screen.

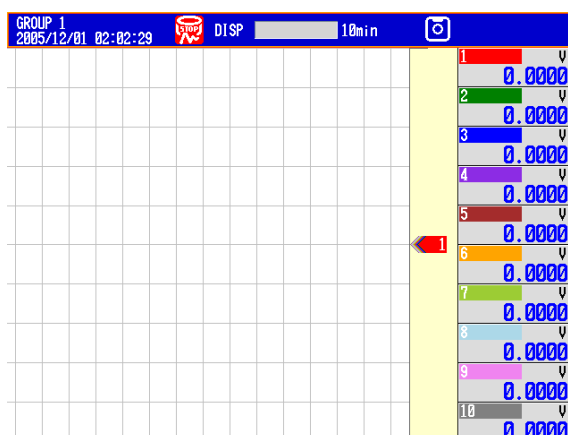

2. Press **MENU** once to display the setting menu.
3. Press the **down arrow key** once to select **Meas. Channel**.
4. Press the **right arrow key** once.

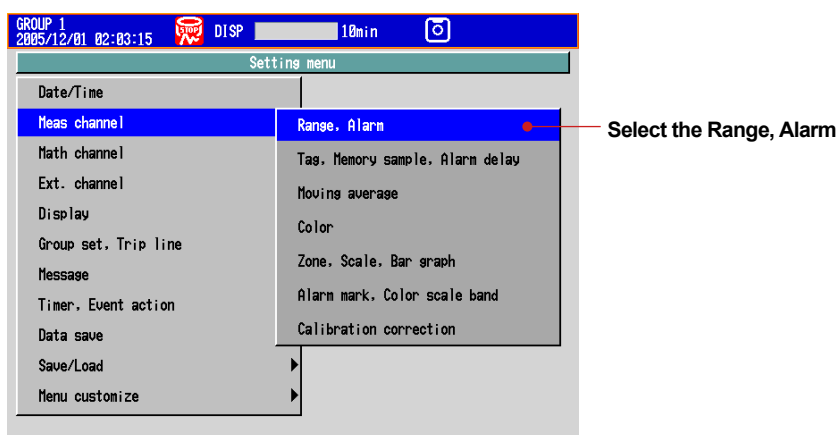

5. Press **DISP/ENTER** once.

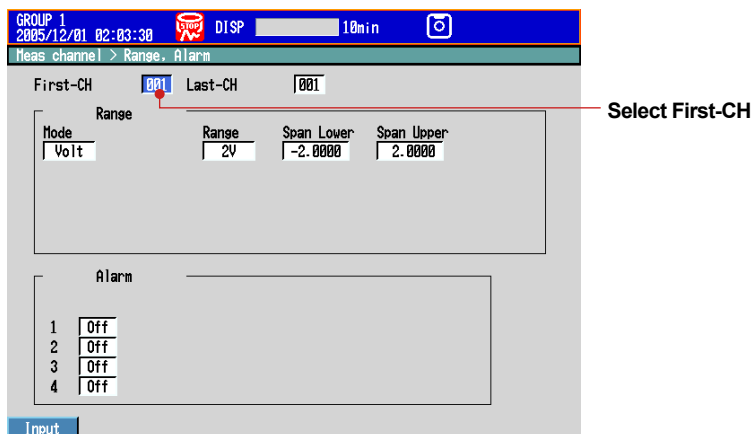

6. Press the **Input** soft key once.

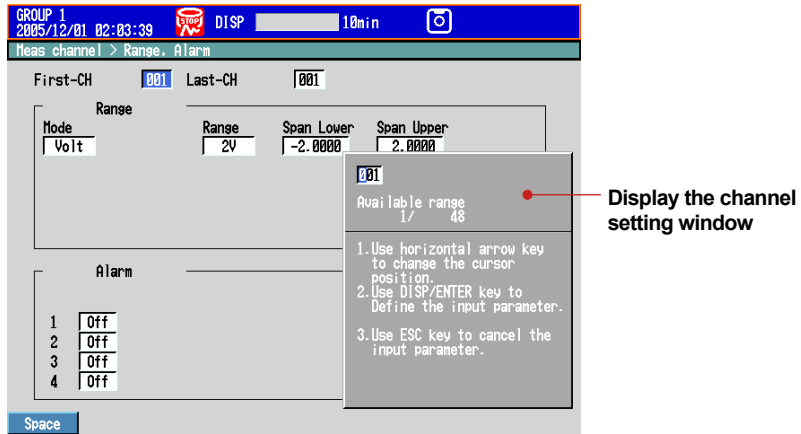

7. Enter 002.

- Select the digit: **Left and right arrow keys**
- Change the value: **Character/Number input keys**
- Delete the value: **Space soft key**
- Cancel the setting: Press **ESC** before pressing **DISP/ENTER**.

8. Press **DISP/ENTER** once. The last channel is also set to 002.

9. Press the **down arrow key** once to move the cursor to **Mode**.

10. Press the **TC** soft key once. The cursor moves to **Range**, and the changed item is displayed in yellow.

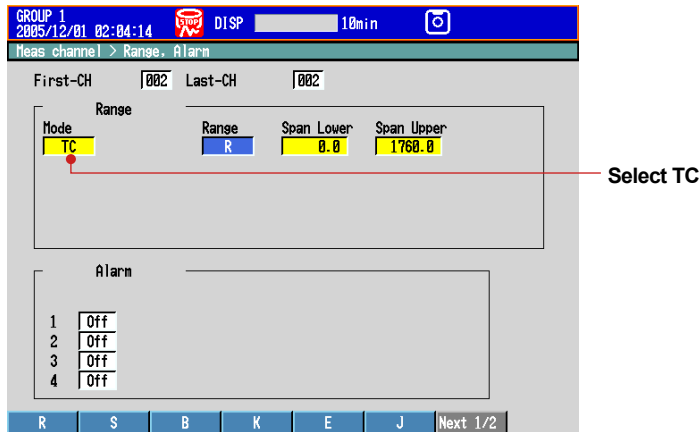

11. Press the **Next** soft key.

12. Press the **T** soft key once. The cursor moves to **Span Lower**.

13. Press the **Input** soft key once.

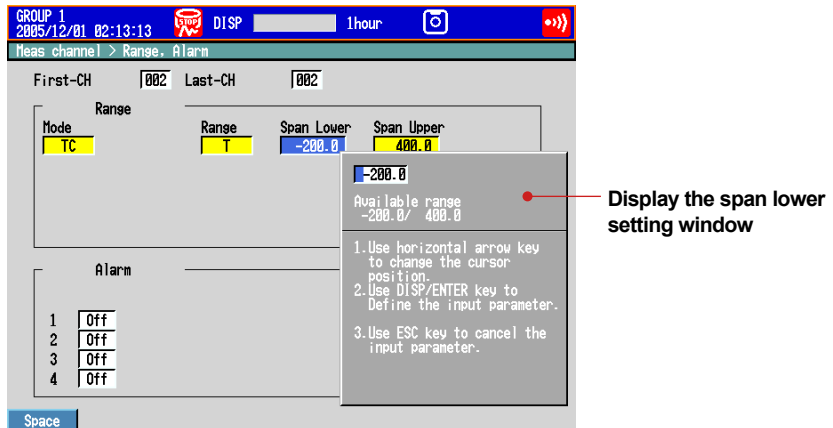

14. Enter 0.0 in the Span Lower box.
See step 7 for the procedure.
15. Press **DISP/ENTER** once. The cursor moves to **Span Upper**.
16. Enter 400.0 in the Span Upper box.
See step 7 for the procedure.
17. Press **DISP/ENTER** once. The changed items are entered, and the cursor returns to First-CH. The changed items change from yellow to white.

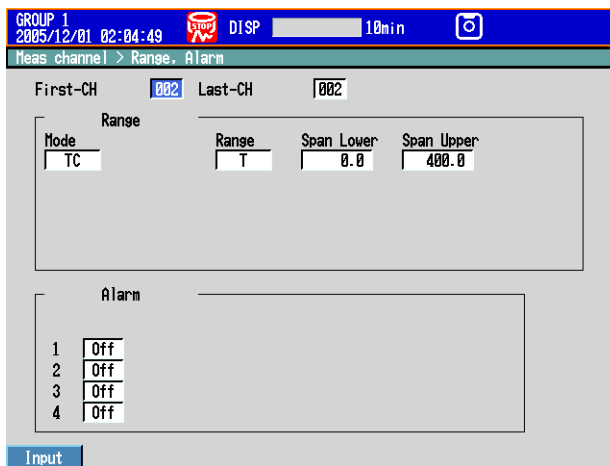

18. Press **ESC** or **MENU** three times to return to the operation mode screen.
Operation complete.

Operation Example in the Basic Setting Mode: Changing the Scan Interval

In this example, we will change the scan interval. Here, the scan interval on the DX2010 is changed to 2 s. The selectable scan intervals are different on the DX2004 and DX2008, but the procedure is the same.

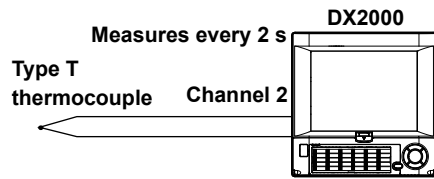

1. Display the operation mode screen.

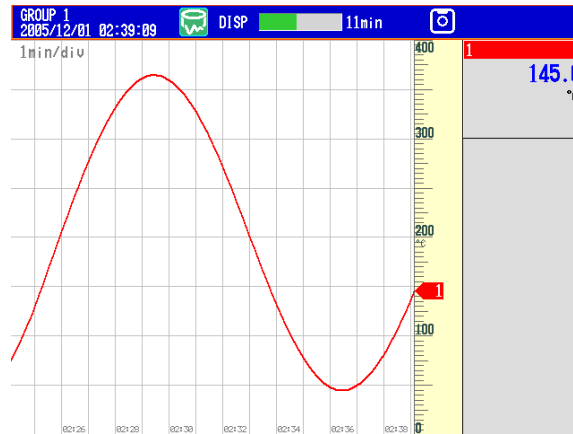

2. Press **MENU** once to display the setting menu.

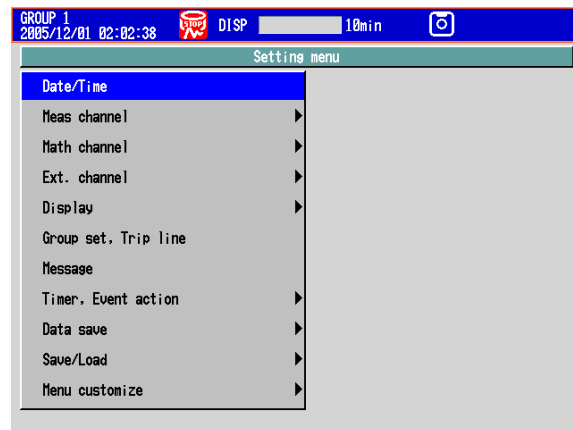

3. Hold down **FUNC** for at least 3 s.

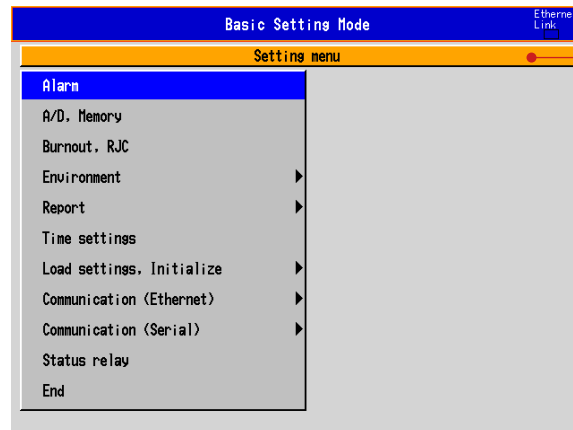

Display the basic setting mode menu

4. Press the **down arrow key** once to select **A/D, Memory**.

5. Press **DISP/ENTER** once.

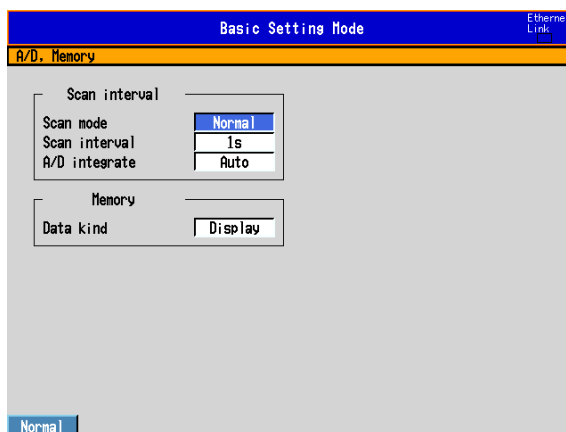

6. Press the **down arrow key** once to move the cursor to **Scan interval**.
7. Press the **2s** soft key once. The cursor moves to **A/D integrate**, and the changed item is displayed in yellow.
- Cancel the setting: Press **ESC** before pressing **DISP/ENTER**.
8. Press **DISP/ENTER** once. The changed items are entered, and the cursor returns to **Scan mode**.

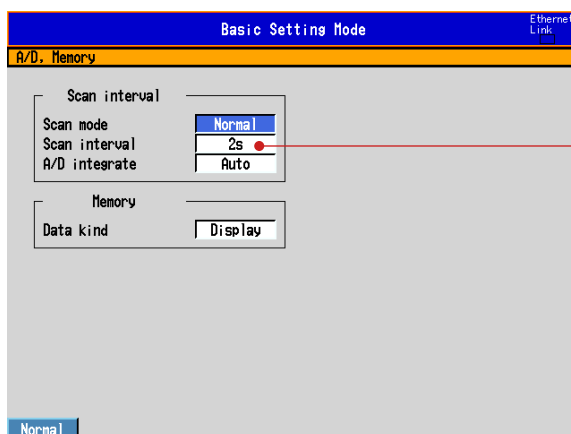

Set the scan interval to 2 s

9. Press **ESC** once to return to the basic setting mode menu.
10. Press the **up arrow key** twice to move the cursor to **End**.
11. Press **DISP/ENTER** once.

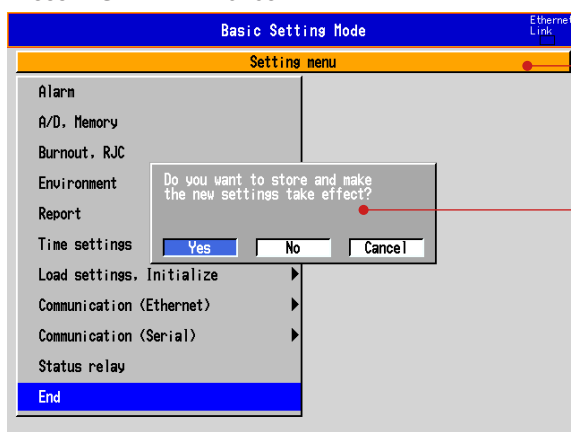

Display the basic setting mode menu

Display the confirmation window

12. Press **DISP/ENTER** once. The settings are saved, and the DX returns to the operation mode screen.

Discard the changes:

Select **No** and press **DISP/ENTER**.

Do not end the basic setting mode:

Select **Cancel** and press **DISP/ENTER**.

Operation complete.

Inserting/Removing a CF Card

Inserting a CF Card

1. Open the operation cover.

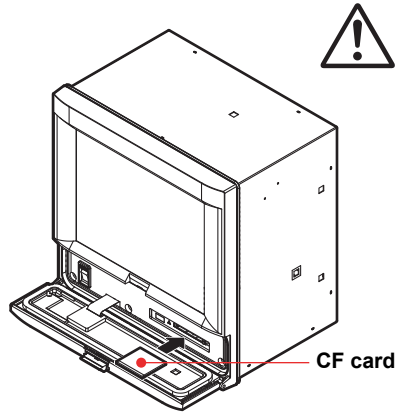

CAUTION

Forcing the CF card into the slot with the upside down may cause damage.

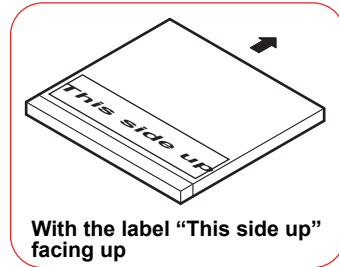

2. Insert the CF card into the slot.

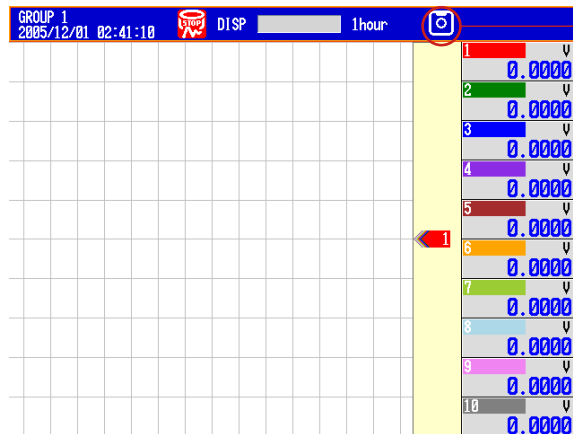

Displays the storage media icon
If the DX does not recognize the CF card, try reinserting it.

3. Close the operation cover.

Operation complete.

Removing a CF Card

<Operations in the Operation Mode>

1. Press **FUNC** once.
2. Press the **Next** soft key.

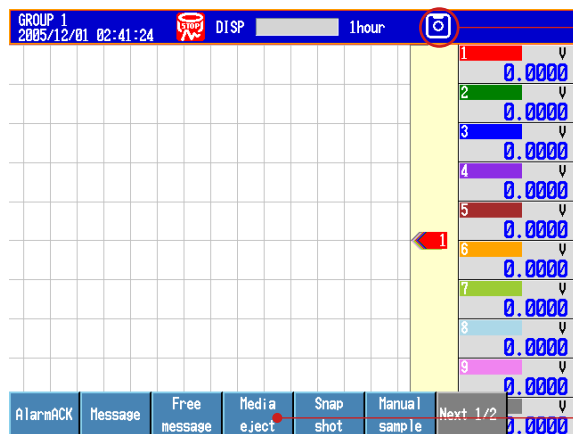

Storage media icon

Media eject

3. Press the **Media eject** soft key once.
4. Press the **CF** soft key once. The message “Media can be removed safely” appears.
5. Open the operation cover.
6. Press the CF card eject button. When you eject the CF card, the storage media icon disappears.

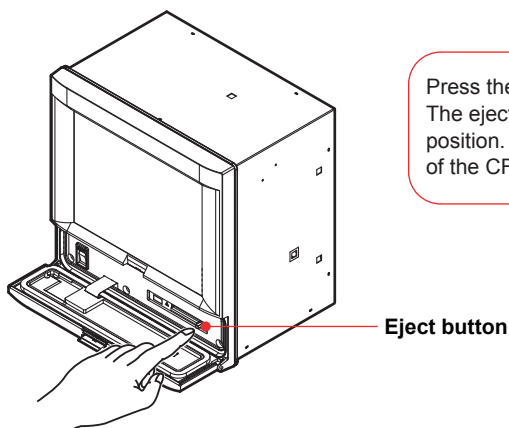

7. Close the operation cover.
- Operation complete.

<Operation in the Basic Setting Mode>

1. Press **MENU** (switch to the setting mode), hold down **FUNC** for 3 s (switch to the basic setting mode), select **Load settings, Initialize > Media eject > CF**, and press **DISP/ENTER**.

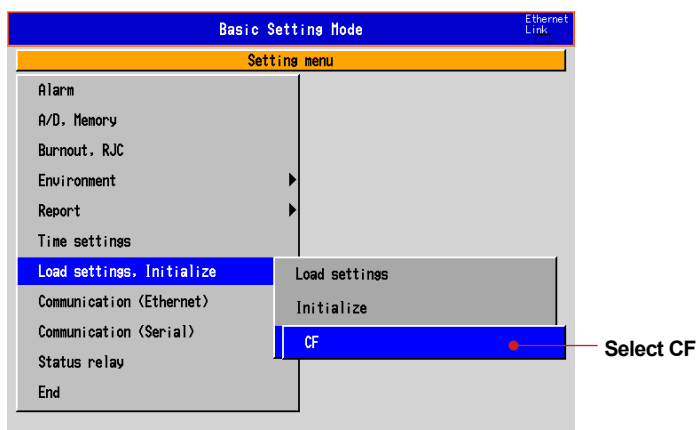

The message “Media can be removed safely” appears.

2. Open the operation cover.
3. Press the CF card eject button. Remove the CF card.
4. Close the operation cover.

Operation complete.

Note

If you remove the CF card without carrying out the media eject procedure, the message “Media was removed compulsorily” appears. Remove the CF card by carrying out the procedure above to prevent damaging the data that is stored.

Saving the Setup Data

In this example, we will save the setup data to a file named “SF2” on the CF card.

1. Display the operation mode screen.

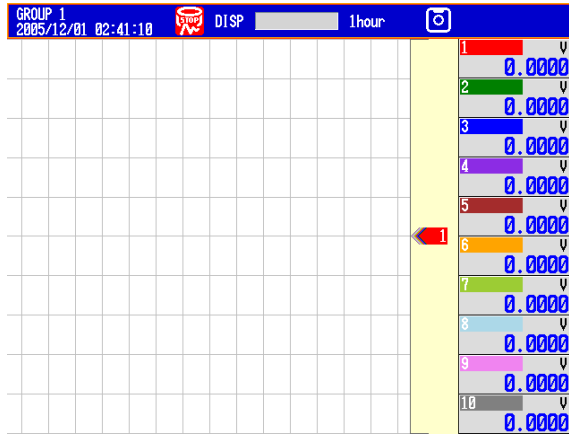

2. Press **MENU** once to display the setting menu.
3. Press the **up arrow key** twice to select **Save/Load**.
4. Press the **right arrow key** once and **down arrow key** three times.

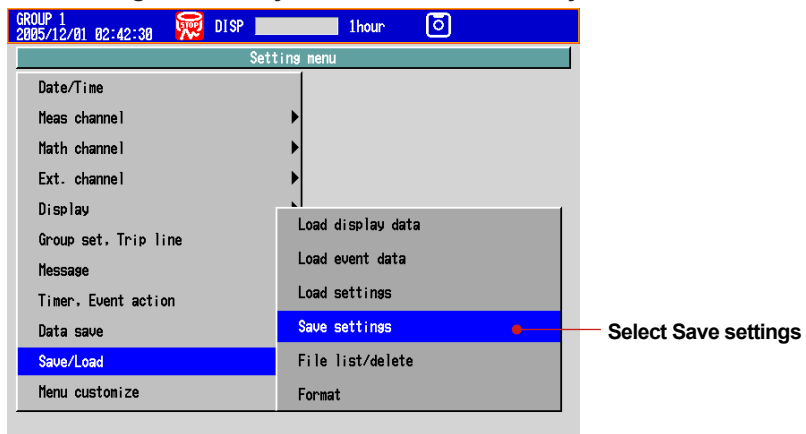

5. Press **DISP/ENTER** once.
6. Enter “SF2” for the file name.
For the input procedure, see “Entering Values and Characters” on page 17.

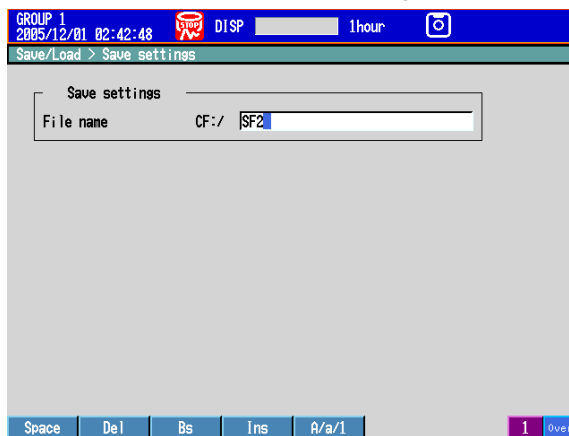

7. Press **DISP/ENTER** once. The message “Data are being saved to media” appears, and the setup data is saved.
8. Press **ESC** or **MENU** three times to return to the operation mode screen.

Operation complete.

Loading the Setup Data

In this example, we will load the setup data “SF2” from the CF card and update the DX settings.

Here, only the setup data of the setting mode is loaded. To load the setup data of both the setting mode and basic setting mode, press **MENU**, hold down **FUNC** for 3 s, select **Load settings, Initialize > Load settings**, and press **DISP/ENTER**.

1. Display the operation mode screen.
2. Press **MENU** once to display the setting menu.
3. Press the **up arrow key** twice to select **Save/Load**.
4. Press the **right arrow key** once and **down arrow key** twice.

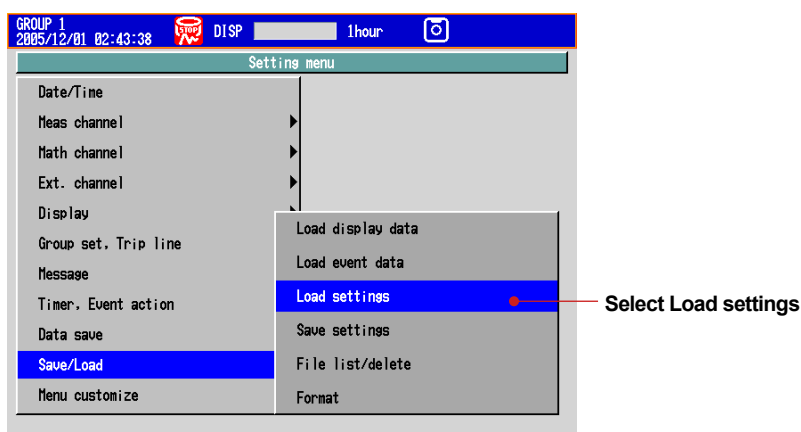

5. Press **DISP/ENTER** once to select the root directory (CF:/).
6. Press **DISP/ENTER** once to display the files in the root directory.
7. Select the file SF2.PDL using the up and down arrow keys.

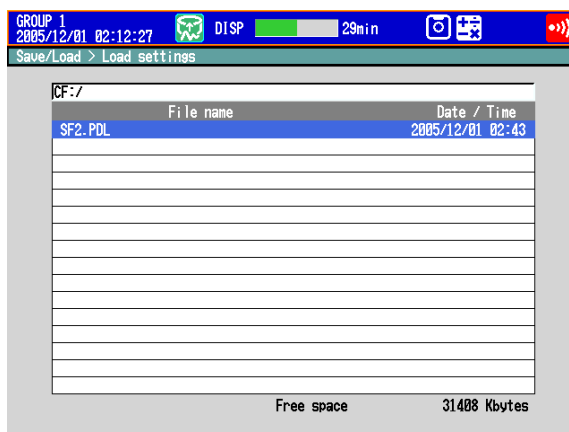

To move to a lower directory, select the directory, and press **DISP/ENTER**.

To move to a higher directory, press **ESC**.

8. Press **DISP/ENTER** once. The message “File is being loaded from media” appears, and the setup data is loaded. The DX automatically returns to the operation mode screen.

Operation complete.

Setting the Input Range and Alarm

Setup Example 1: Temperature Measurement Channel

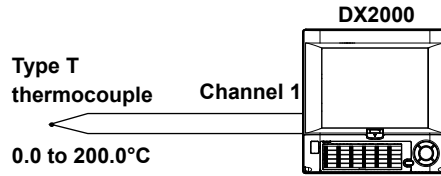

| Setup Item | Description | Number in the Figure |
|-------------|---------------------|----------------------|
| Channel | Use channel 1. | 1 |
| Tag | TI-001 | 2 |
| Sensor | Type T thermocouple | 3 |
| Input range | 0.0 to 200.0°C | 4 |

(1) Input Range

Press **MENU** (switch to the setting mode).

From the setting menu, select **Meas Channel > Range, Alarm**.

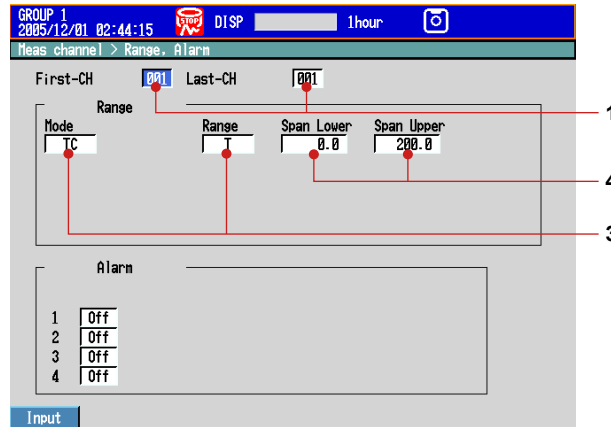

(2) Tag

From the setting menu, select **Meas Channel > Tag, Memory sample, Alarm delay**.

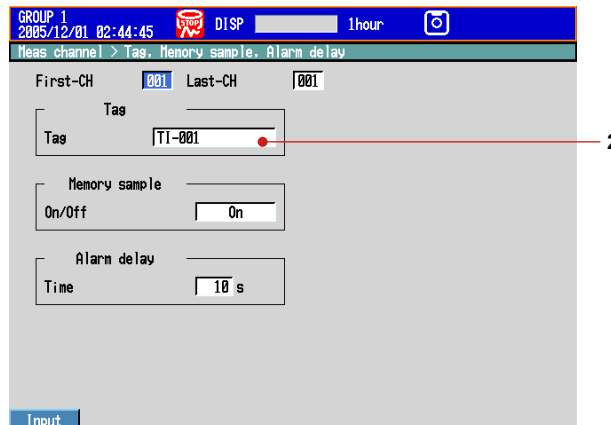

Operation complete.

Setup Example 2: Flow Rate Measurement Channel and Alarm

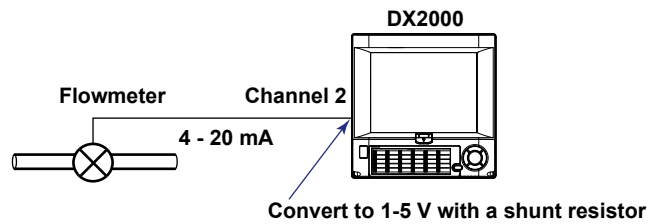

| Setup Item | Description | Number in the Figure |
|-----------------|--|----------------------|
| Channel | Use channel 2. | 1 |
| Tag | FI-002 | 2 |
| Input signal | 1-5V | 3 |
| Input range | 0.0 to 500.0 L/H | 4 |
| Alarm condition | Output an alarm if the measured value is less than or equal to 120.0 L/H. Output destination: Relay contact (I03) | 5 |

(1) Input Range and Alarm

Press **MENU** (switch to the setting mode).

From the setting menu, select **Meas Channel > Range, Alarm**.

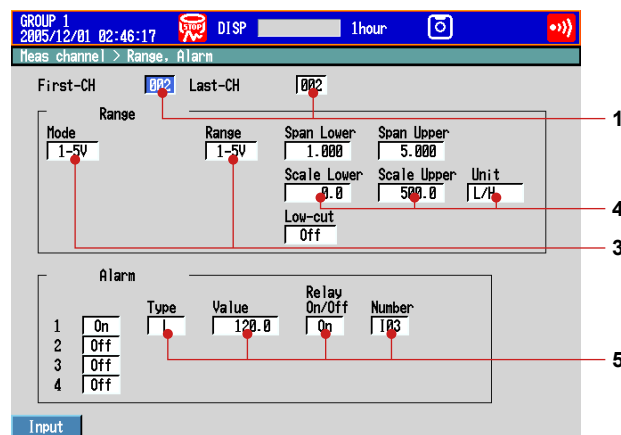

(2) Tag

From the setting menu, select **Meas Channel > Tag, Memory sample, Alarm delay**.

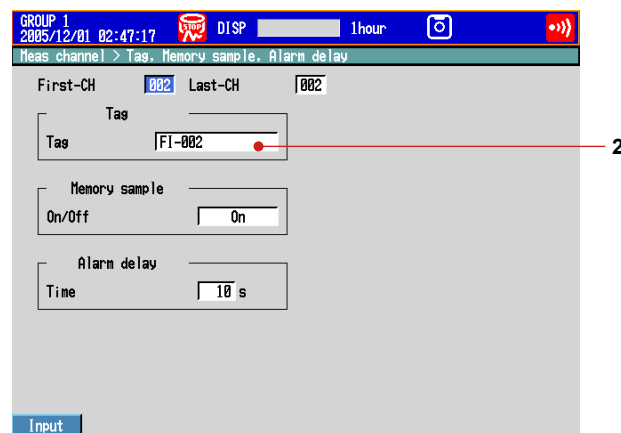

Operation complete.

Setting the Display

Setup Example 3: Assigning Channels to Groups

In this example, we will assign channels 1 and 2 to group 1.

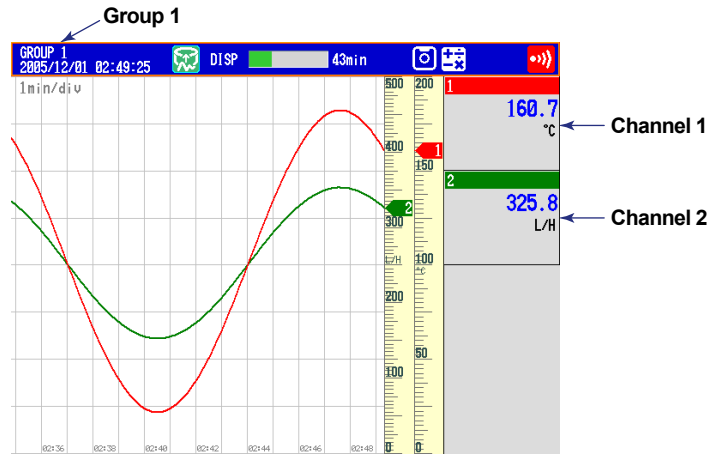

| Setup Item | Description | Number in the Figure |
|------------|------------------------------------|----------------------|
| Group | Assign channel 1 and 2 to group 1. | 1 |

(1) Group

Press **MENU** key (switch to the setting mode) and select **Group set, Trip line**.

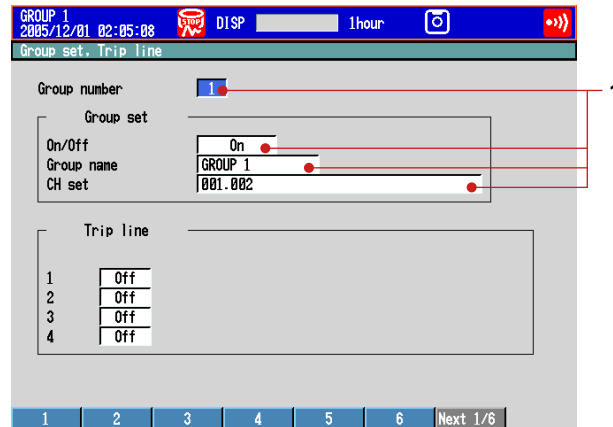

Operation complete.

Setup Example 4: Setting the Time Scale

Set the time per division of the trend waveform to 2 minutes.

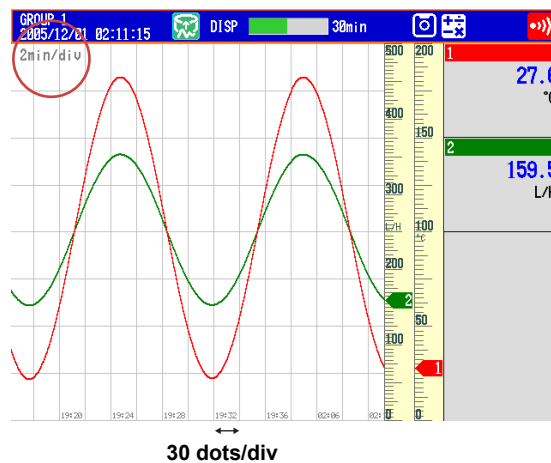

The sampling interval (the time corresponding to 1 dot) is 4 s when the trend interval is 2 min. $30 \text{ dots} \times 4 \text{ s} = 2 \text{ min}$

| Setup Item | Description | Number in the Figure |
|----------------|--|----------------------|
| Trend interval | Set the time per division to 2 minutes. The waveform is updated at every 4 s. | 1 |

(1) Trend Interval

Press **MENU** (switch to the setting mode) and select **Display > Trend/Save interval**.

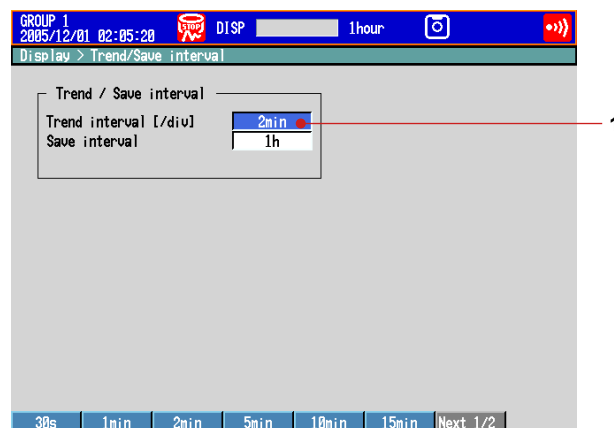

Operation complete.

Setting the Data Storage

Setup Example 5: Continuously Record Measured Data and Automatically Save

In this example, we will continuously record and save the measured data of channel 1 and 2.

For the procedure to set the channel, see “Setting the Input Range and Alarm” on page 28.

For the procedure to set groups, see “Setting the Display” on page 30.

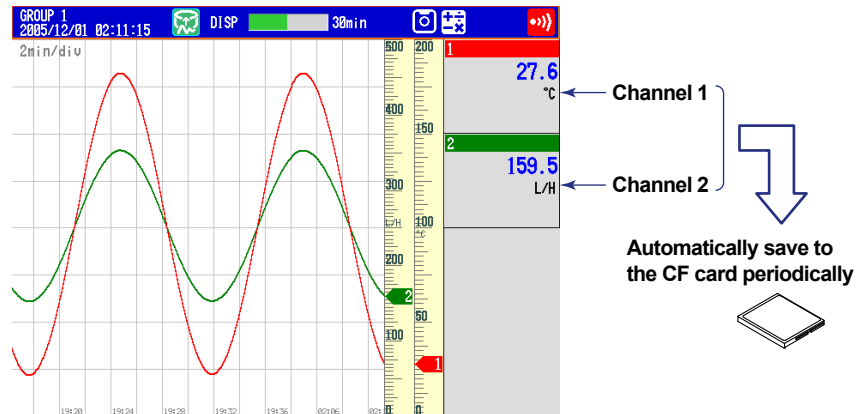

| Setup Item | Description | Number in the Figure |
|----------------------------|---|----------------------|
| Source channels | Channel 1 (TI-001) and channel 2 (FI-002) | 1 |
| Data to be recorded | Continuously record the display data from the start of the measurement. | 2 |
| Data storage method | Automatically store every 24 hours. | 3 |
| Sampling interval | 4 seconds. Set using the trend interval. | 4 |
| | Sampling interval = (trend interval setting)/30 dots | |
| Data file name | Add "sample" to the file name. Example: 000123_sampleYYMMDD_HHMMSS.DAD | 5 |
| | Sequential number Date/Time of the first recorded data | |
| Save Destination Directory | DATA-101 | 6 |

(1) Data to be Recorded

Press **MENU** (switch to the setting mode), hold down **FUNC** for 3 s (switch to the basic setting mode).

From the basic setting menu, select **A/D, Memory**.

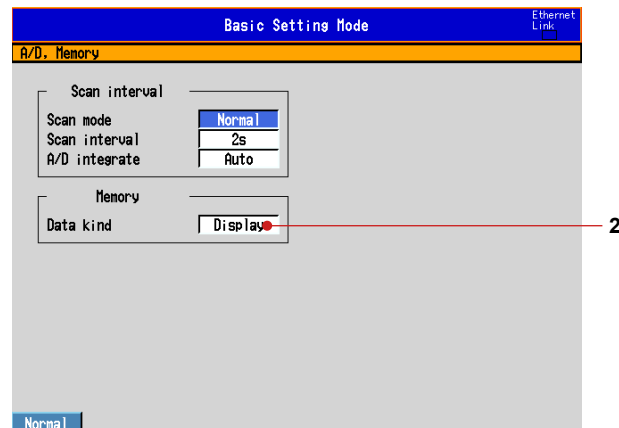

(2) Method of Storing to the CF Card (Auto Save ON/OFF)

Press **MENU** (switch to the setting mode), hold down **FUNC** for 3 s (switch to the basic setting mode).

From the basic setting menu, select **Environment > Security, Media save, Batch**.

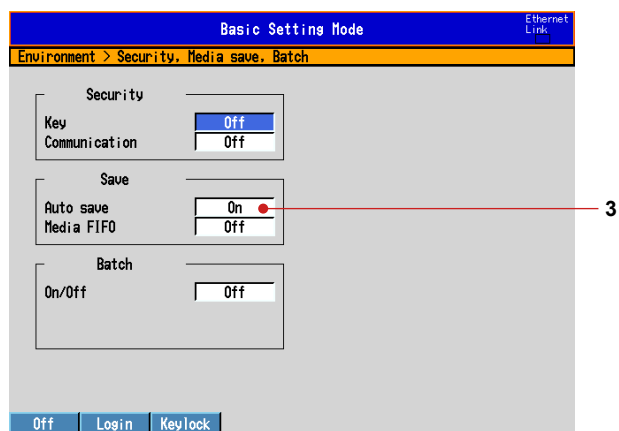
**(3) Save the Settings**

1. Press **ESC** to return to the basic setting menu.
2. Select **End** and press **DISP/ENTER**.
The window appears for you to confirm the saving of the settings.
3. Select **Yes** and press **DISP/ENTER**.
The DX returns to the operation mode screen.

(4) Channels to Be Recorded

Press **MENU** (switch to the setting mode).

From the setting menu, select **Meas Channel > Tag, Memory sample, Alarm delay**.

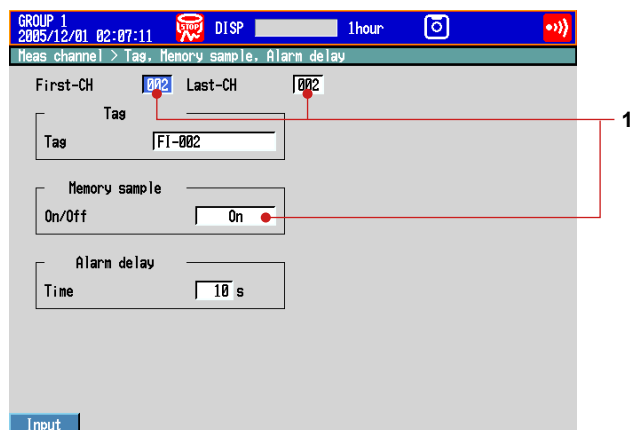

(5) Interval for Saving the Data to the CF Card

From the setting menu, select **Display > Trend/Save interval**.

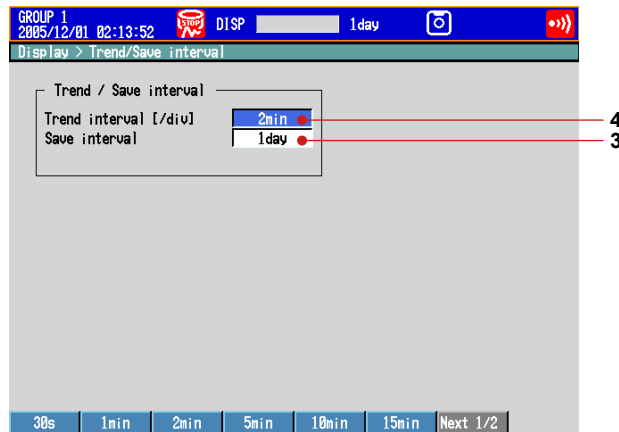

(6) Data File Name

From the setting menu, select **Data save > File header, Data file name**.

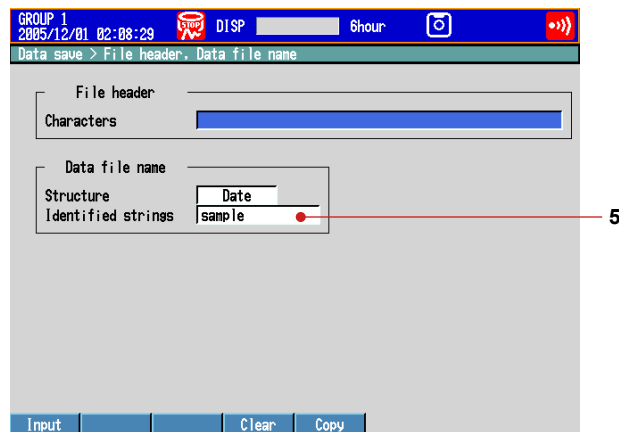

(7) Save Destination Directory (within the CF Card)

From the setting menu, select **Data save > Save directory**.

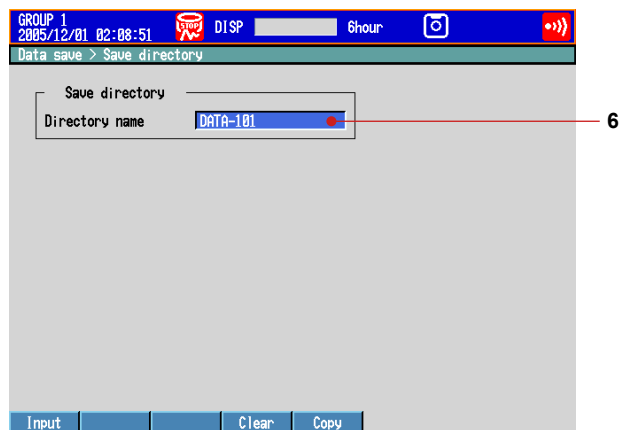

Operation complete.

Setup Example 6: Saving Measured Data at the Specified Time

Using the settings of Setup Example 5, we will save the measured data once at hour 0 every day.

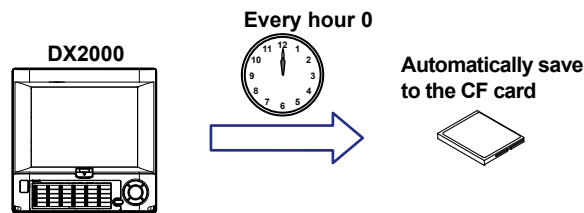

All settings other than those listed below are the same as Setup Example 5.

| Setup Item | Description | Number in the Figure |
|---------------------|---|----------------------|
| Data storage time | Save the data once at hour 0 every day. | 7 |
| Data storage method | Automatically save the measured data at the specified time. | 8 |

(1) Setting the Time

Press **MENU** (switch to the setting mode).

From the setting menu, select **Timer, Event action > Match time timer**.

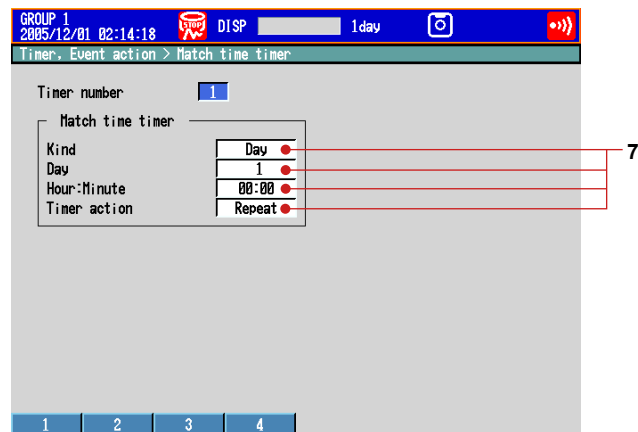

(2) Specifying the Data Storage

Press **MENU** (switch to the setting mode).

From the setting menu, select **Timer, Event action > Event action**.

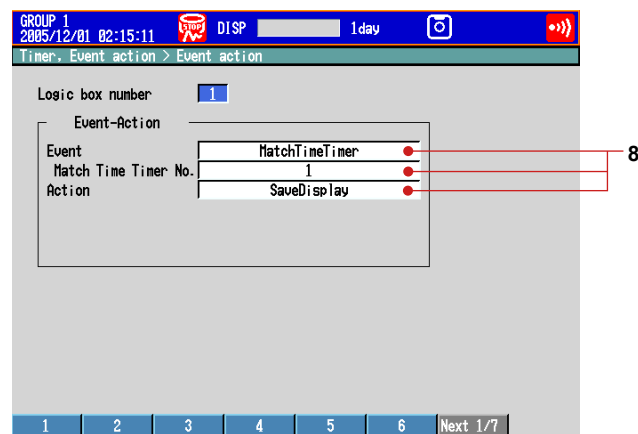

Operation complete.

Customizing the Operation

Setup Example 7: Assigning the Screen Image Data Storage Function to the USER key

In this example, we will set the DX so that the displayed screen image data can be saved to the CF card by pressing the USER key. This function is called *snapshot*. The extension of snapshot data files is .png.

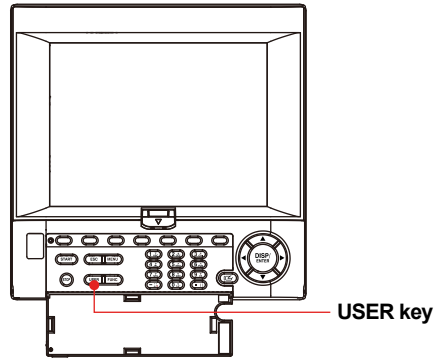

| Setup Item | Description | Number in the Figure |
|--------------|--|----------------------|
| Event action | Save the screen image data of the DX using the USER key. | 1 |

(1) Assigning an Action to the USER Key

Press **MENU** (switch to the setting mode) and select **Timer, Event action > Event action**.

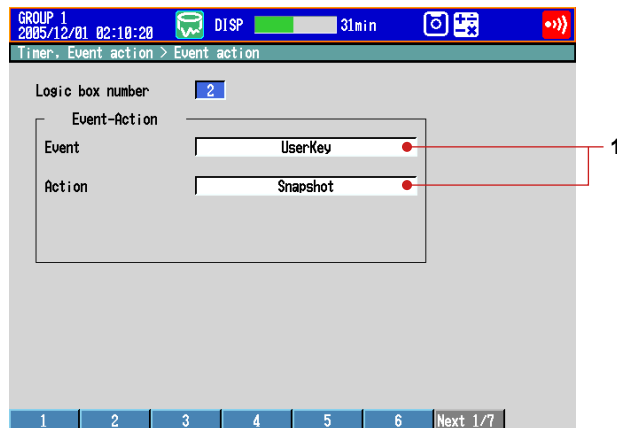

Operation complete.

Setup Example 8: Registering Frequently Used Screens to the Favorite Key

Up to eight operation mode screens that are frequently used can be registered to the Favorite key. This enables you to monitor the operation by using only the Favorite key. This feature is convenient when comparing data such as historical trends.

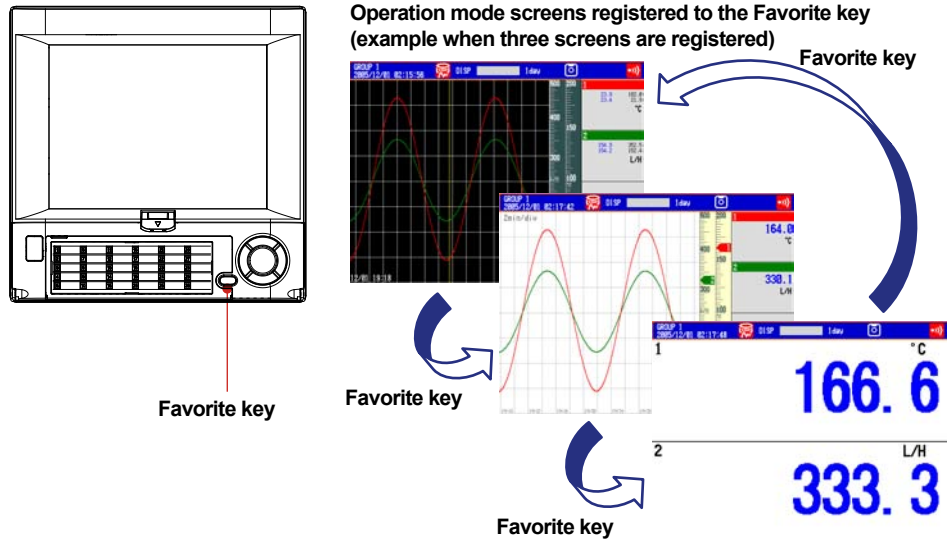

1. Display the screen to be registered.

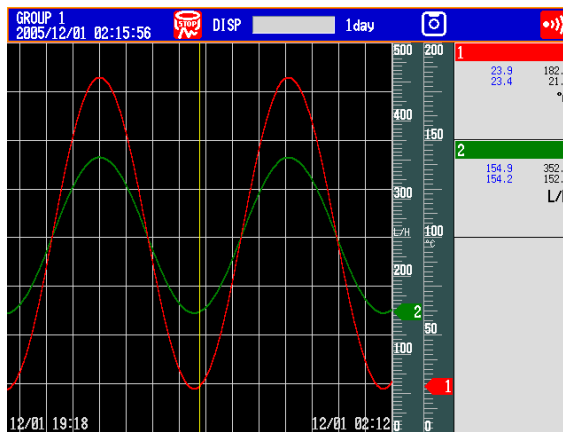

2. Press **FUNC** once to display the FUNC key menu.
3. Press the **Next** soft key to display Favorite regist.
4. Press the **Favorite regist** soft key to display the registration list window.

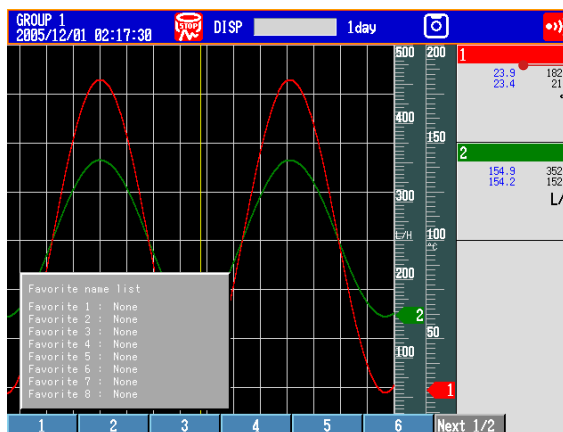

Register the historical trend to the Favorite key

5. Press the favorite number (1 to 8) soft key.
6. Press the **Register** soft key.

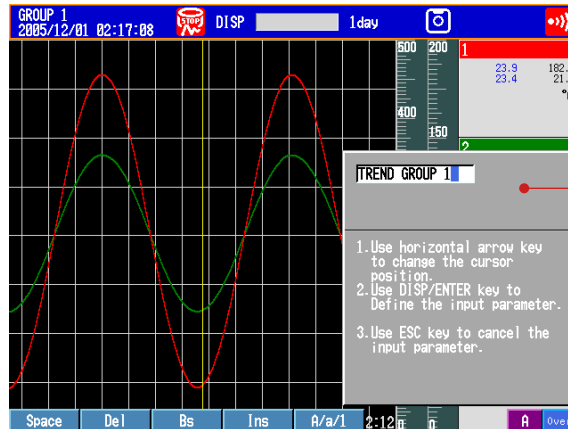

Show the window for entering the display name

7. Enter the screen name.
Select the digit: **Left and right arrow keys**
Enter characters: **Character/Number input keys**
Delete a character: **Space soft key**
Cancel the setting: Press **ESC** before pressing **DISP/ENTER**.
For the input procedure, see "Entering Values and Characters" on page 17.
 8. Press **DISP/ENTER** once.
 9. Repeat steps 1 to 8 to register up to eight screens.
- Operation complete.

Operation

Starting the Memory Sample

1. Press **START** once.
Memory sample starts.

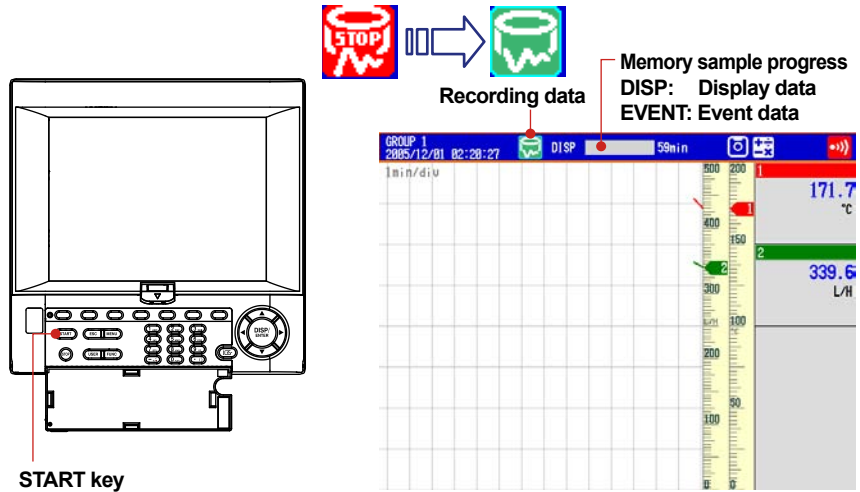

Operation complete.

Stopping the Memory Sample

1. Press **STOP** once.

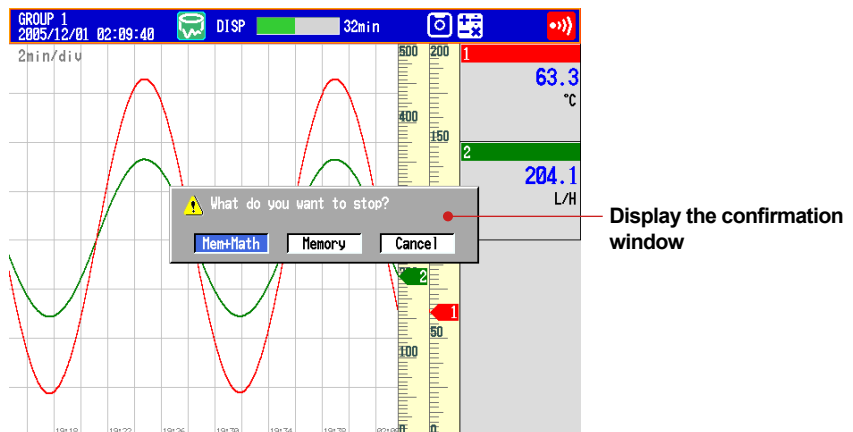

2. Select **Mem+Math** or **Memory** using the left and right arrow keys.

Memory: Stops memory sample.

Mem+Math: Stops memory sample and computation (option).

On models without the computation function (option), the confirmation message "Do you want to stop data storage?" appears. Select **Yes**.

3. Press **DISP/ENTER** once.



Stop memory sampling.

Operation complete.

Switching the Trend Display, Digital Display, and Bar Graph Display

1. Press **DISP/ENTER** once to show the display selection menu.

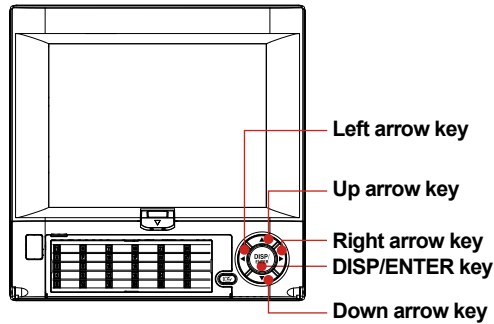

2. Press the **down arrow key** to select **TREND**, **DIGITAL**, or **BAR**.
3. Press the **right arrow key** once to display the sub menu. To close the sub menu that you opened, press the **left arrow key**.
4. Press the **down arrow key** to select the group.

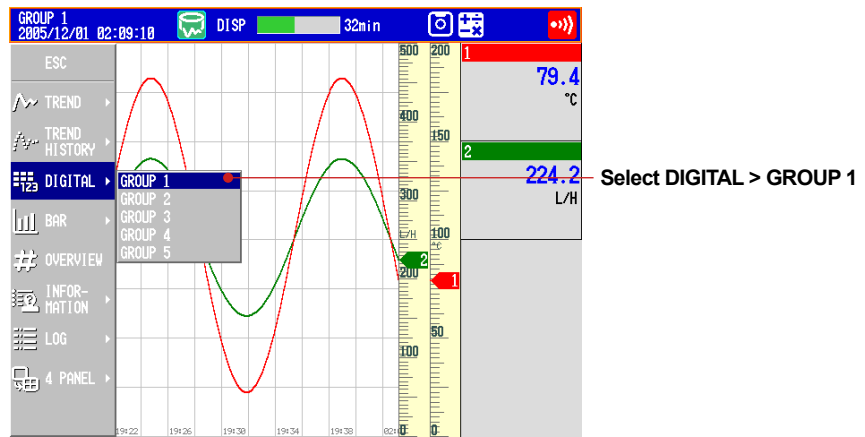

5. Press **DISP/ENTER** once to show the operation display of the selected group. To close the menu without switching the display, press **ESC**.

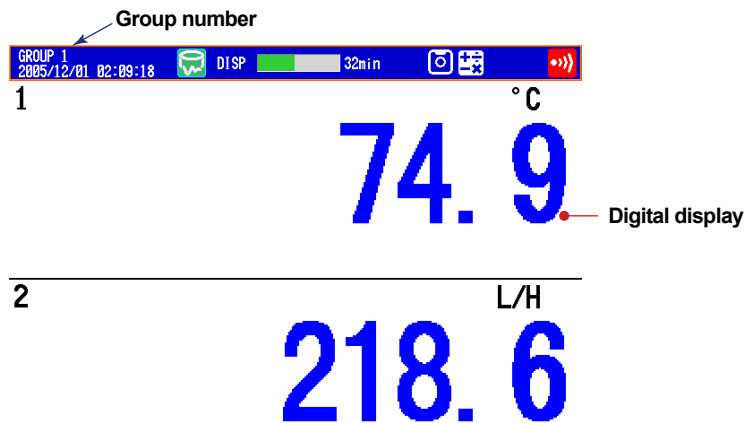

Operation complete.

Press the **down arrow key** when the trend, digital, or bar graph is displayed to switch the display in the order trend, digital, bar graph, trend, and so on. Press the **up arrow key** to switch the display in reverse order. Press the **right arrow key** or the **left arrow key** to switch the group.

Writing the Message “START”

Registering the Word “START” in Message Number 1

1. Press **MENU** (switch to the setting mode) and select **Message**.
Press **DISP/ENTER**, the **down arrow key** once, and the **Input** soft key to show the message registration window.

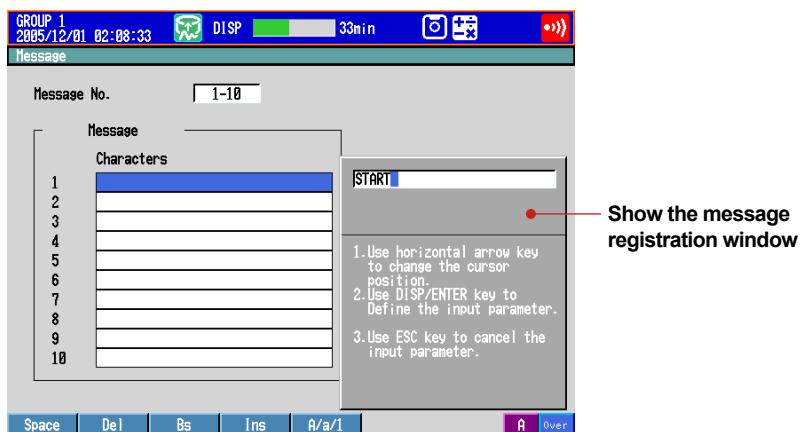

- Select the digit: **Left and right arrow keys**
- Enter characters: **Character/Number input keys**
- Delete a character: **Space soft key**
- Cancel the setting: Press **ESC** before pressing **DISP/ENTER**.

For the input procedure, see “Entering Values and Characters” on page 17.

2. Press **DISP/ENTER**.

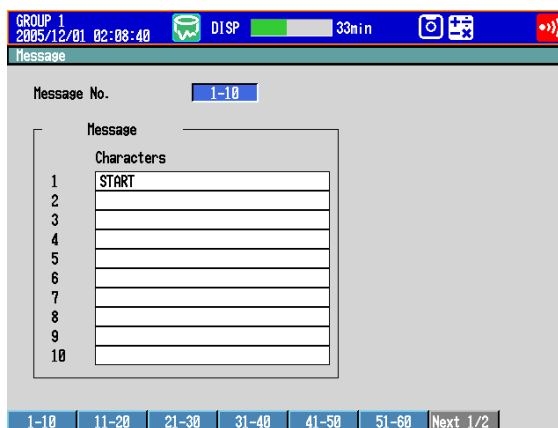

3. Press **ESC** or **MENU** twice to return to the operation mode screen.

Operation complete.

Writing Message Number 1 “START”

This operation can be carried out while memory sample is in progress. The message is displayed on the trend display. Show the trend display first.

1. Press **FUNC** (display the FUNC key menu), press the **Message** soft key, and press the **1 - 10** soft key.

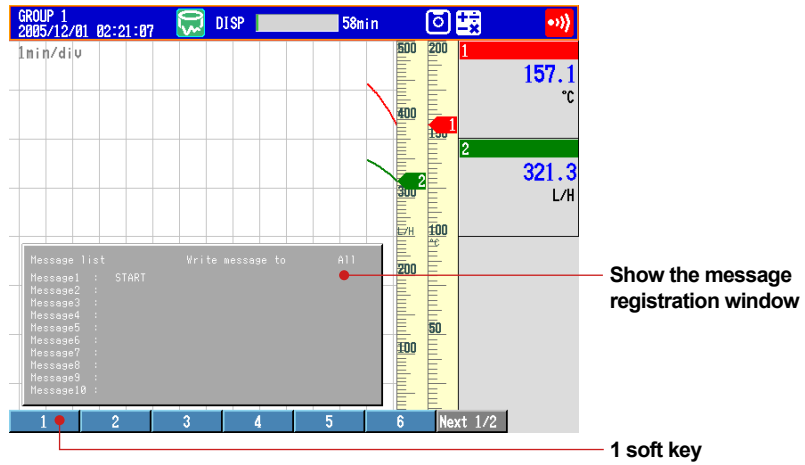

2. Press the **1** soft key.

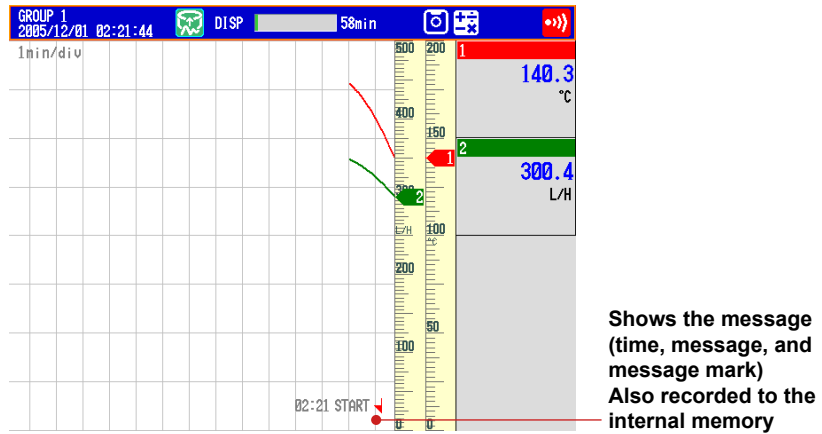

Operation complete.

Connecting to an Ethernet Network

Setup Example 9: Monitoring the DX on a PC Browser

In this example, we will connect the PC and the DX via hub in a one-to-one relationship and display and monitor the DX screen on a browser on the PC.

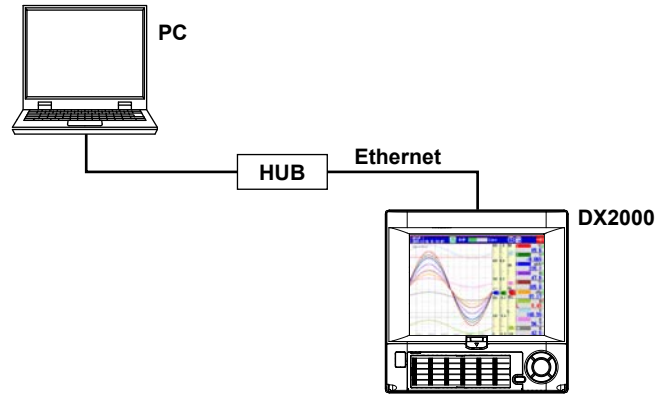

DX

| Setup Item | Description | Number in the Figure |
|---------------------|---|----------------------|
| IP address | 192.168.1.101 | 1 |
| Subnet mask | 255.255.255.0 | |
| Web server function | Monitor from a Web browser on the PC using operator page. | 2 |
| Access to the DX | Display the Web page and do not set access privileges. | 3 |

PC

| Setup Item | Description | Number in the Figure |
|-------------|---------------|----------------------|
| IP address | 192.168.1.100 | 4 |
| Subnet mask | 255.255.255.0 | |

(1) IP Address of the DX

Press **MENU** (switch to the setting mode), hold down **FUNC** for 3 s (switch to the basic setting mode).

From the basic setting menu, select **Communication (Ethernet) > IP address, Host settings**.

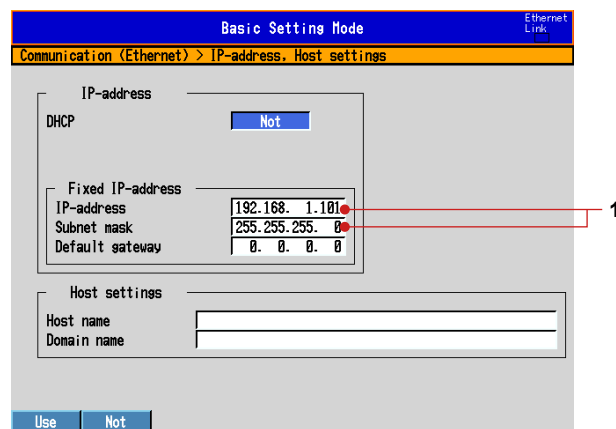

(2) Enabling the Web Server Function on the DX

From the basic setting menu, select **Communication (Ethernet) > Server**.

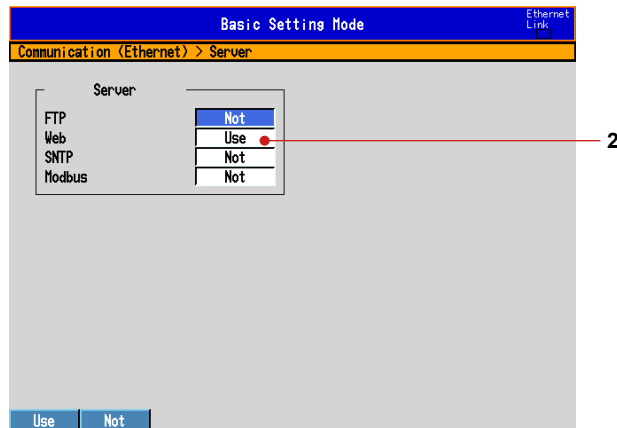

(3) Display the DX Screen on the PC

From the basic setting menu, select **Communication (Ethernet) > Web page**.

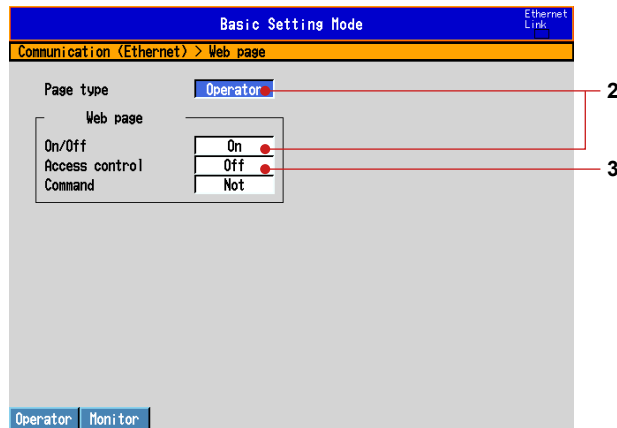

(4) Save the Settings

1. Press **ESC** to return to the basic setting menu.
2. Select **End** and press **DISP/ENTER**.
The window appears for you to confirm the saving of the settings.
3. Select **Yes** and press **DISP/ENTER**.
The DX returns to the operation mode screen.

(5) Setting the PC

Set the IP address and subnet mask on the PC.

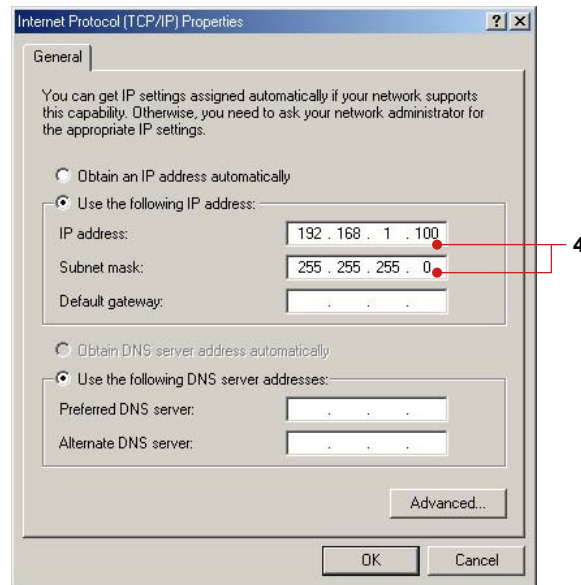
**(6) Checking the Connection**

Send the command below from the PC and check that a correct response is returned.

Send

```
>ping 192.168.1.101
```

Response example

```
>Reply from 192.168.1.101: bytes=32 time<10ms TTL=255
```

(7) Displaying the DX Screen on the Browser

1. Start the browser on the PC.
2. Enter the following URL.
`http://192.168.1.101/operator.htm`
3. Check that the DX screen appears.

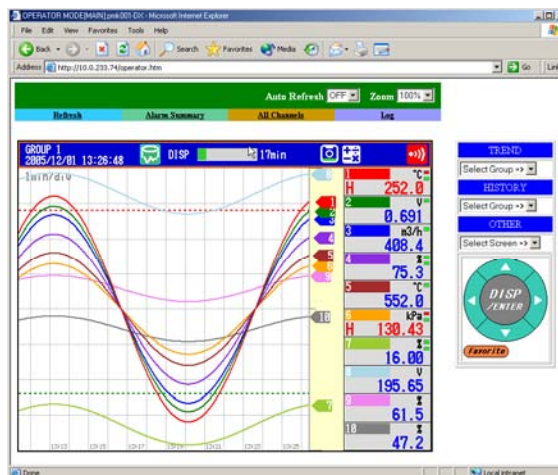

Operation complete.

Setup Example 10: Automatically Transferring the Measured Data File to an FTP Server

In this example, we will configure the DX so that the measured data is automatically transferred to an FTP server on the network when the measured data is automatically saved to the CF card. To automatically transfer the measured data files and report files, the auto saving of the measured data must be configured in advance (see “Data storage method” of the setup example 5).

This example assumes that the following network environment is used: DHCP enabled, automatically obtain the DNS server information, and automatically register the DX host name to the DNS server. Set the parameters according to your network environment.

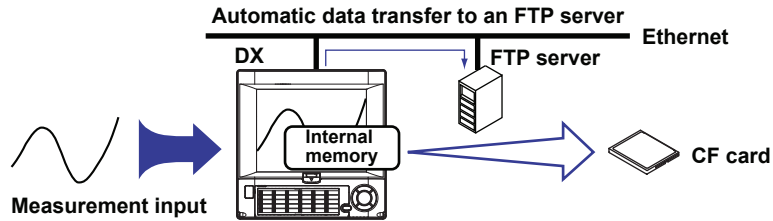

| Setup Item | Description | Number in the Figure |
|--------------------------------|-----------------------------|----------------------|
| Host name | DAQSTATION1 | 1 |
| Obtain the IP address | Obtain automatically (DHCP) | 2 |
| Type of data to be transferred | Acquired measured data | 3 |
| FTP server | Server name | abcdefg.co.jp |
| | Port number | 21 |
| | Login name | FTPUSER1 |
| | Password | a1234 |

(1) Host Settings and IP Address of the DX

Press **MENU** (switch to the setting mode), hold down **FUNC** for 3 s (switch to the basic setting mode).

From the basic setting menu, select **Communication (Ethernet) > IP address, Host settings**.

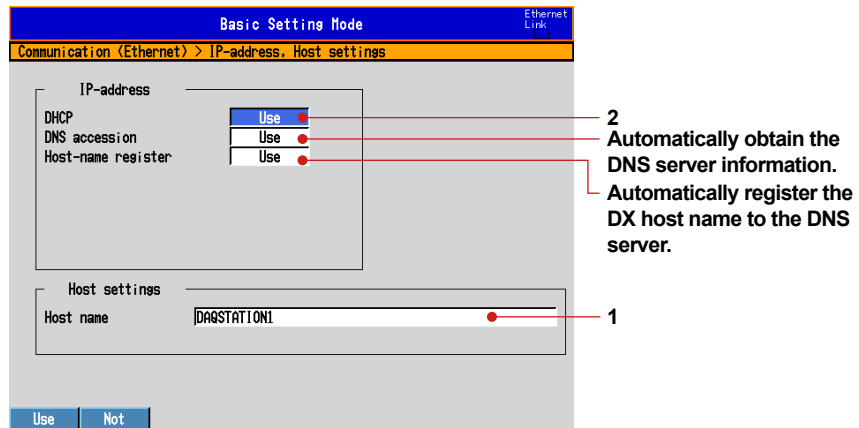

(2) Data to Be Transferred to the FTP Server and the FTP Server

From the basic setting menu, select **Communication (Ethernet) > FTP client**.

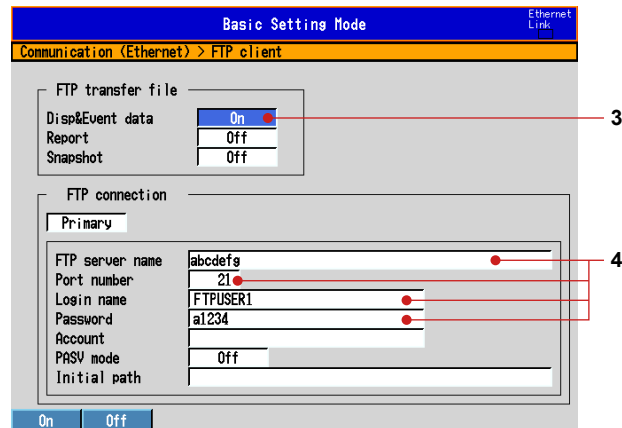

(3) Save the Settings

1. Press **ESC** to return to the basic setting menu.
 2. Select **End** and press **DISP/ENTER**.
The window appears for you to confirm the saving of the settings.
 3. Select **Yes** and press **DISP/ENTER**.
The DX returns to the operation mode screen.
- Operation complete.

Executing a File Transfer Test

1. Press **FUNC** once to display the FUNC key menu.
2. Press the **FTP test** soft key once.

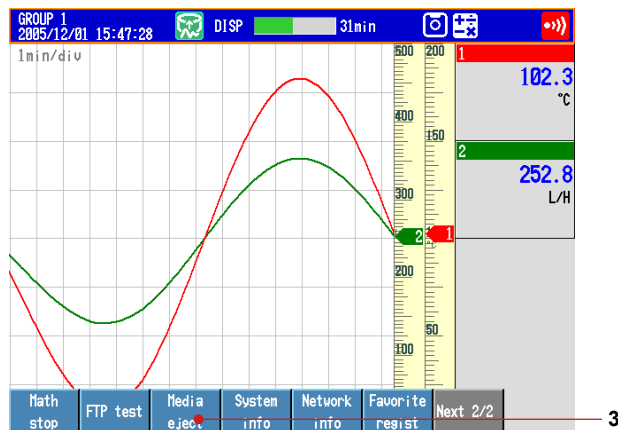

3. Press the **Primary** soft key once. The messages “FTP test is being executed” and “Execution is complete” are displayed. The test file (FTP_TEST.TXT) is sent to the FTP server.
- Operation complete.

Transferring the Data Files

When you start memory sample, the measured data file is transferred to the FTP server when the data is saved to the CF card.

Using DAQSTANDARD

Displaying the Measured Data on DAQSTANDARD

In this example, we will display the measured data using the accompanying software program, DAQSTANDARD.

1. Insert the CF card containing the measured data file (.DAD or .DAE extension) into the PC that has DAQSTANDARD installed.
2. Start DAQSTANDARD. The launcher is displayed.



Data viewer icon

3. Click the data viewer icon to start the data viewer.

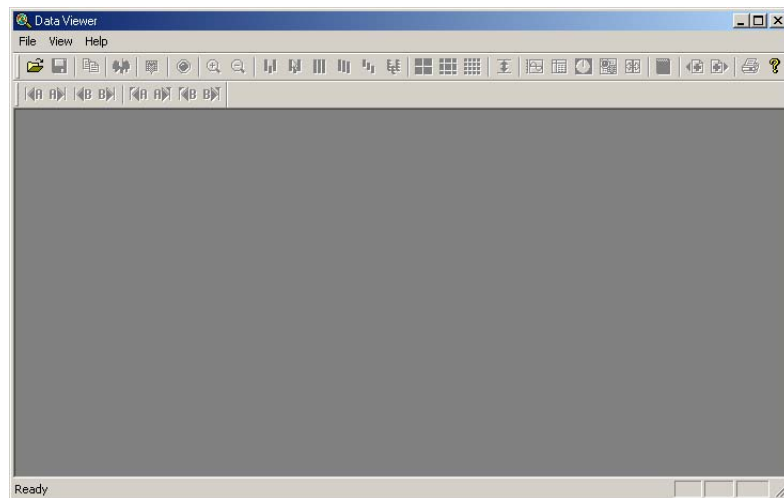

4. From the **File** menu, choose **Open**.
5. In the Open dialog box, select the desired file, and click **Open**.
The data is displayed.

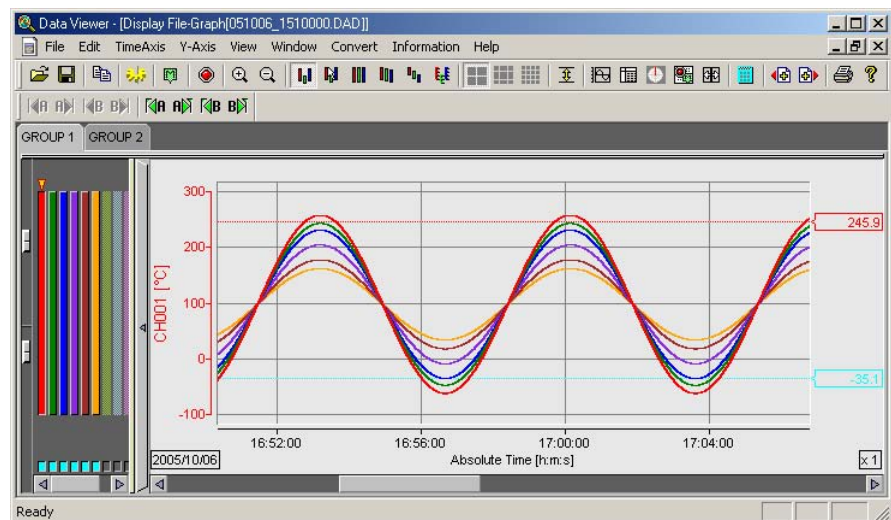

Operation complete.

Installation and Wiring

Installation Location

Install the DX indoors in a location that meets the following conditions.

- **Instrumentation Panel**

The DX is designed to be installed in an instrumentation panel except for the desktop type.

- **Well-Ventilated Location**

To prevent overheating, install the DX in a well-ventilated location. For the panel cut dimensions when arranging multiple DXs, see the page 51. Follow the panel cut dimensions providing adequate space between instruments when other instruments are arranged on the panel. For the desktop type, we recommend that a space of at least 50 mm be provided around the left, right, and top panels of the DX.

- **Minimum Mechanical Vibrations**

Choose an installation location with the minimum mechanical vibration. Installing the DX in a location with large mechanical vibration not only causes adverse effects on the mechanism but also may hinder normal recording.

- **Horizontal**

Install the DX horizontally (However, the DX can be inclined up to 30 degrees backwards for panel mounting).

Note

Condensation may occur if the DX is moved to another place where the ambient temperature is higher, or if the temperature changes rapidly. In addition, measurement errors will result when using thermocouples. If this happens, let the DX adjust to the new environment for at least one hour before using it.

Do not install the DX in the following places.

- **Outdoors**

- **In Direct Sunlight or Near Heat Sources**

Install the DX in a place with small temperature fluctuations near room temperature (23°C). Placing the DX in direct sunlight or near heat appliances can cause adverse effects on the internal circuitry.

- **Where an Excessive Amount of Soot, Steam, Moisture, Dust, or Corrosive Gases Are Present**

Soot, steam, moisture, dust, and corrosive gases will adversely affect the DX. Avoid such locations.

- **Near Strong Magnetic Field Sources**

Do not bring magnets or instruments that produce electromagnetic fields close to the DX. Operating the DX in strong magnetic fields can cause errors in the measurements.

- **Where the Viewing of the Display Is Poor**

The DX uses a TFT color LCD for the display. Therefore, viewing of the display from an extreme angle is difficult. Install the DX so that the user can view the display from the front.

Installation Procedure

Installation Procedure (Panel Mount Type)

Use a steel panel of thickness 2 mm to 26 mm.

1. Insert DX from the front of the panel.
2. Mount the DX to the panel using the mounting brackets that come with the package as shown in the figure below.
 - Use two brackets to support the top and bottom or the left and right sides of the case (remove the seal that is covering the holes for the mounting brackets beforehand).
 - The proper torque for tightening the mounting screws is 0.7 to 0.9 N•m.
 - Mount the DX to the rack according to the procedure below.
 - First, attach the two mounting brackets and temporarily fasten the attachment screws.
 - Next, fix the DX in place by tightening the attachment screws with the appropriate torque. When the DX is approximately perpendicular to the panel as you fasten the screws, press the mounting bracket against the case so that they are in contact with each other.



CAUTION

- Tightening the screws too much can deform the case or damage the bracket.
- Be careful not to insert foreign objects or tools through the holes for the mounting brackets in the case.
- Make sure the rubber gasket is affixed so that it does not become entangled between the main unit and the panel. Affixing the gasket incorrectly will result in failure to achieve sufficient dust and water proof performance.

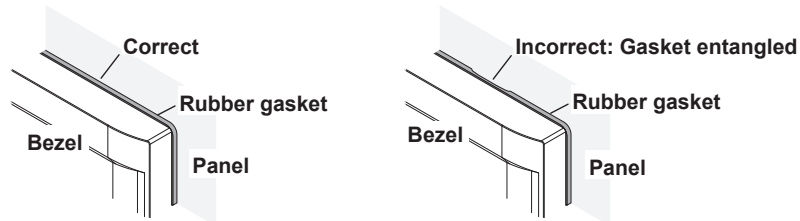

Panel Mounting Diagram

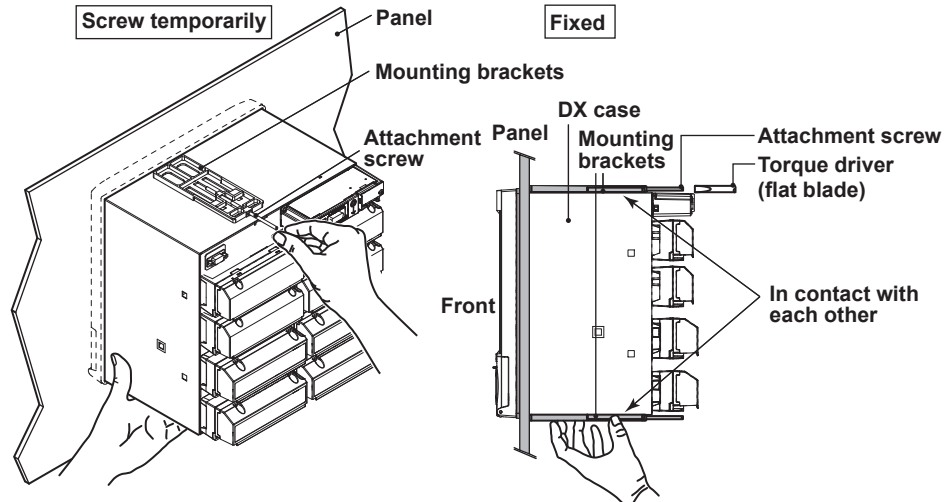

(The figure shows the case when the mounting brackets are used on the top and bottom of the case.)

Note

To achieve sufficient dust and water proof performance, mount the DX in the middle of the panel cut out.

External Dimensions and Panel Cut Dimensions Panel Mount Type

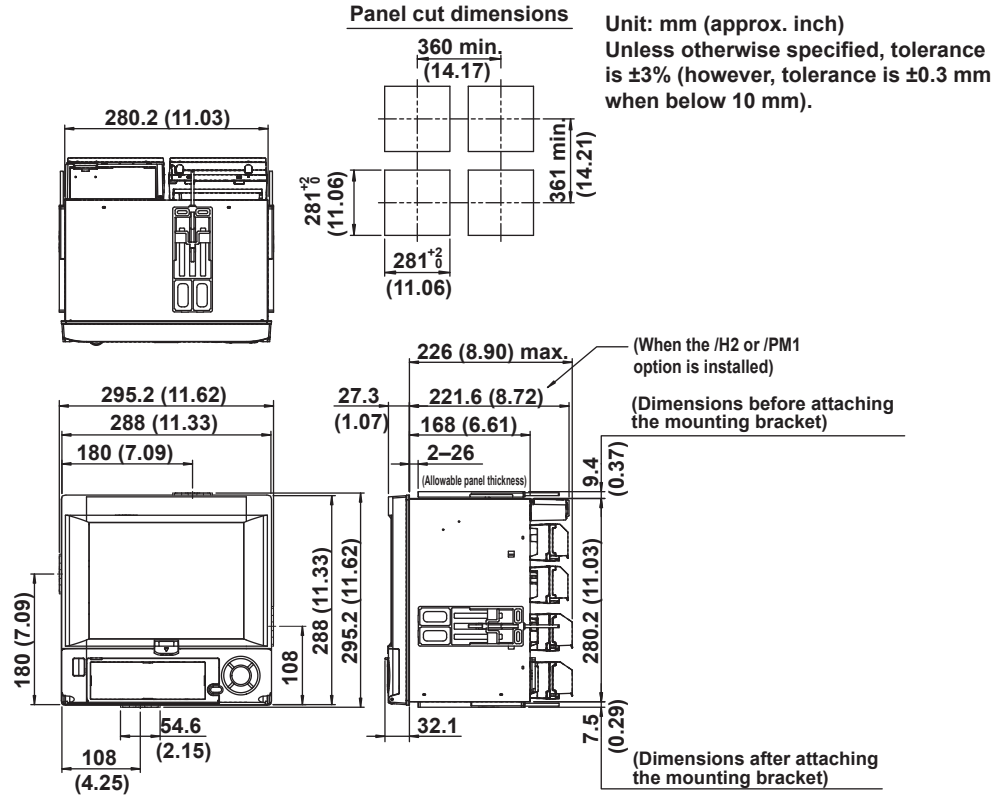

Desktop Type (/H5[] Option)

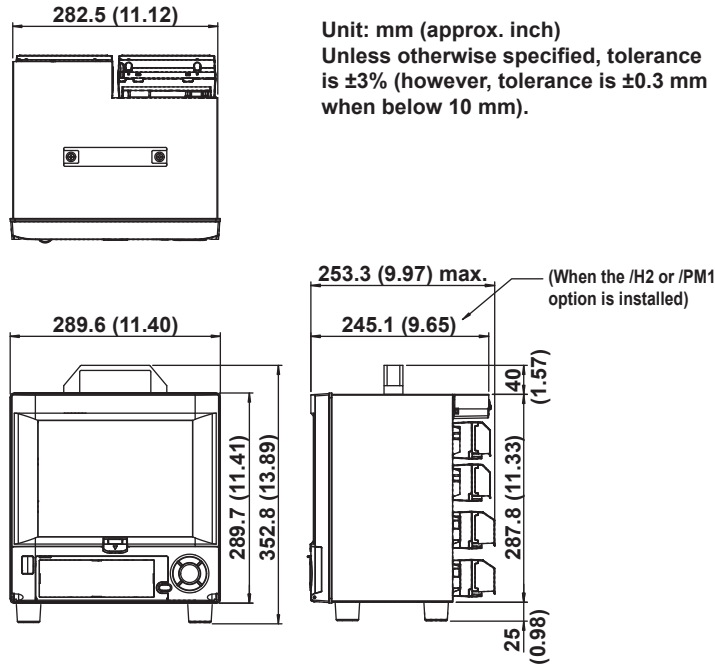

Input Signal Wiring



WARNING

- To prevent electric shock while wiring, ensure that the power supply source is turned OFF.

CAUTION

- If a strong tension is applied to the cable wired to the DX, the terminals of the DX and/or the cable can be damaged. In order to prevent tension from being applied directly on the terminals, fasten all wiring cables to the rear of the mounting panel.
- To prevent fire, use signal wires having a temperature rating of 70°C or more.
- Do not apply a voltage exceeding the following value to the input terminals. Otherwise, damage to the DX may result.
 - Maximum input voltage: ± 60 VDC
 - Maximum common mode voltage: ± 60 VDC (under measurement category II conditions)
- The DX is a product of installation category II.

Precautions to Be Taken While Wiring

Take the following precautions when wiring the input signal cables.

When using a screw terminal, we recommend that you use a crimp-on lug with an insulation sleeve (designed for 4-mm screws).



Crimp-on lug with insulation sleeves (for 4 mm screws)

When using a clamp terminal (H2), we recommend that you use the following kind of cable:

- Conductive cross-sectional area: 0.08 mm^2 to 1.5 mm^2 (AWG 28 to 16)
- Length of the stripped section of the wire: Approx. 7 mm

Take measures to prevent noise from entering the measurement circuit.

- Move the measurement circuit away from the power cable (power circuit) and ground circuit.
- It is desirable that the object being measured does not generate noise. However, if this is unavoidable, isolate the measurement circuit from the object. Also, ground the object being measured.
- Shielded wires should be used to minimize noise caused by electrostatic induction. Connect the shield to the ground terminal of the DX as necessary (make sure you are not grounding at two points).
- To minimize noise caused by electromagnetic induction, twist the measurement circuit wires at short, equal intervals.
- Make sure to earth ground the protective ground terminal through minimum resistance (less than 100Ω).

When using internal reference junction compensation on the thermocouple input, take measures to stabilize the temperature at the input terminal.

- Always use the terminal cover.
- Do not use thick wires which may cause large heat dissipation (cross sectional area of 0.5 mm^2 or less recommended).
- Make sure that the ambient temperature remains reasonably stable. Large temperature fluctuations can occur if a nearby fan turns ON or OFF.

Connecting the input wires in parallel with other devices can cause signal degradation, affecting all connected devices. If you need to make a parallel connection, then

- Turn the burnout detection function OFF.
- Ground the instruments to the same point.
- Do not turn ON or OFF another instrument during operation. This can have adverse effects on the other instruments.
- RTDs cannot be wired in parallel.

Wiring Procedure

A terminal cover is screwed in place on the measuring input terminal block on the rear panel. A label indicating the terminal arrangement is affixed to the cover.

1. Turn OFF the DX and remove the terminal cover.
2. Connect the signal wires to the terminals.
3. Replace the terminal cover and fasten it with screws. The proper torque for tightening the screws is 0.6 N-m.

Note

Input signal wires of diameter less than or equal to 0.3 mm may not be secured firmly for clamped terminals (/H2). Fold over the conducting section of the wire, for example, to make sure that the wire is securely connected to the clamped terminal.

Arrangement of the Input Terminals

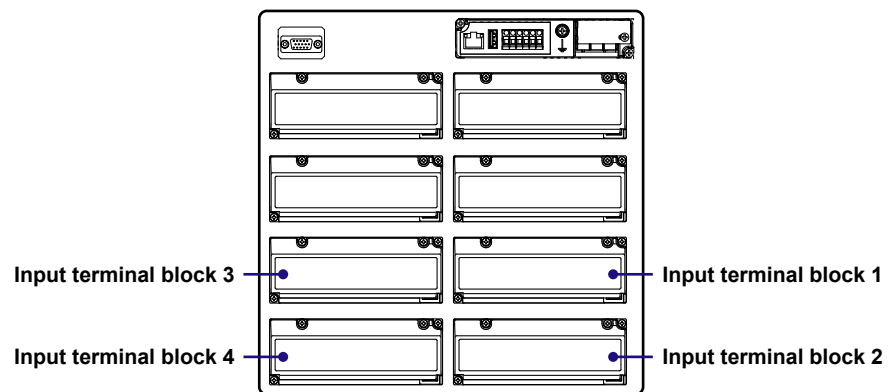

| Input terminal block | Channel Assignments by Model | | | | | | |
|----------------------|------------------------------|--------|--------|--------|--------|--------|--------|
| | DX2004 | DX2008 | DX2010 | DX2020 | DX2030 | DX2040 | DX2048 |
| 1 | 1-4 | 1-4 | 1-10 | 1-10 | 1-10 | 1-10 | 1-12 |
| 2 | | 5-8 | | 11-20 | 11-20 | 11-20 | 13-24 |
| 3 | | | | | 21-30 | 21-30 | 25-36 |
| 4 | | | | | | 31-40 | 37-48 |

Screw terminal

Clamp terminal

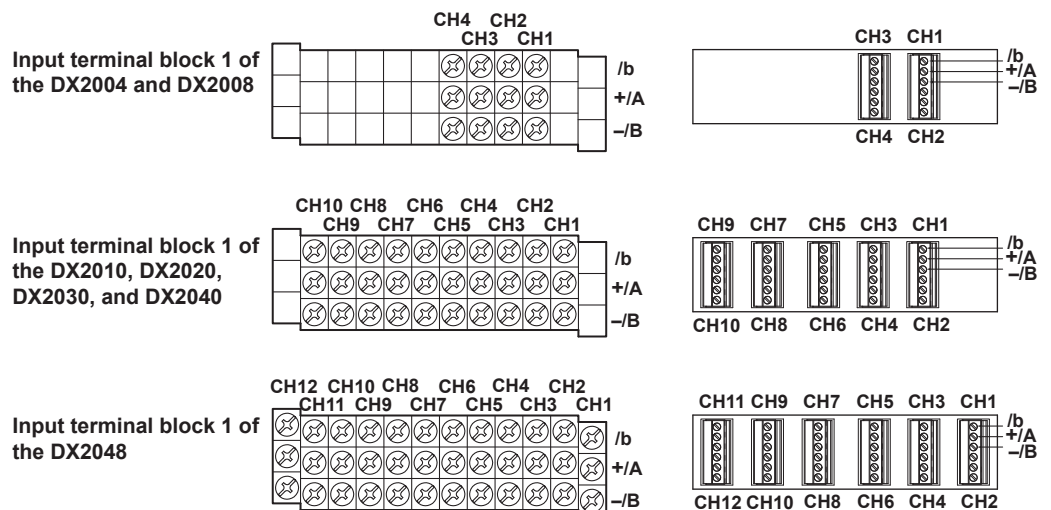

Wiring Screw Terminals

DC voltage input/DI (ON/OFF) input

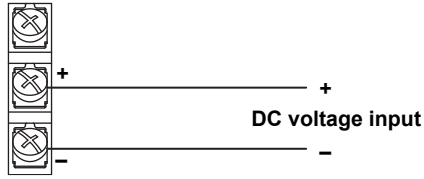

TC input

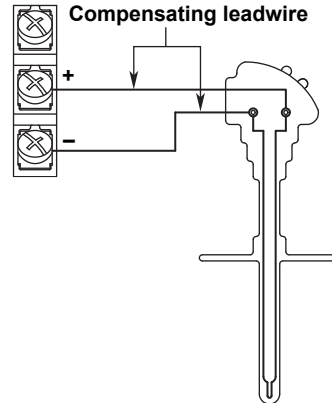

RTD input

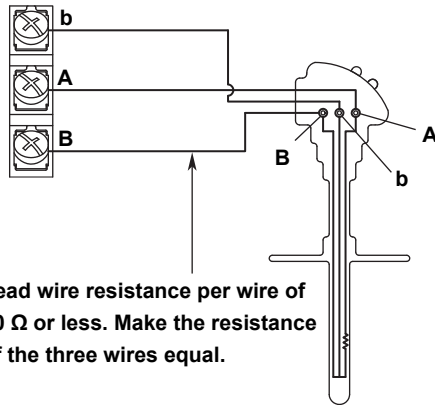

DC current input

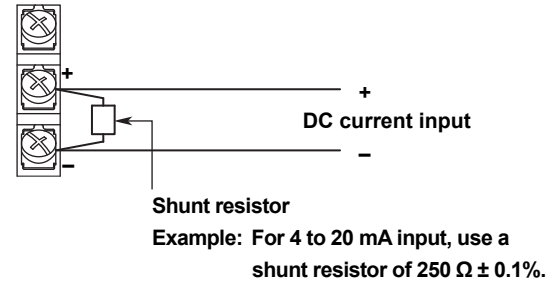

Wiring Clamped Terminals

Remove the terminal block
Hold both ends of the terminal block and pull straight.

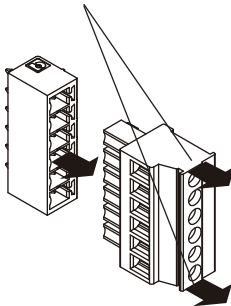

Connect the wires

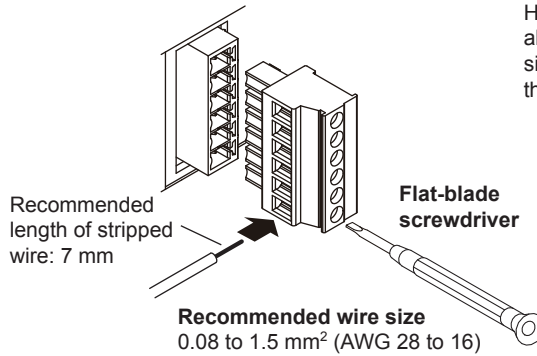

Connect the terminal block
Hold both ends of the terminal block, align with the connector on the DX side, and push the terminal block into the connector.

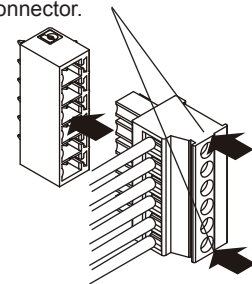

Input signal wire
First, loosen the screw at the front using a flat-blade screwdriver. Insert the input signal wire into the slit on the left side of the terminal block, and fasten the screw at the front.

Note

RTD input terminals A and B are isolated on each channel. Terminal b is shorted internally across all channels. However, terminal b is also isolated on each channel on models with the /N1 option (Cu10, Cu25 RTD input/3 leg isolated RTD) and /N2 option (3 leg isolated RTD).

Optional Terminal Wiring



WARNING

- To prevent electric shock while wiring, ensure that the power supply source is turned OFF.
- If a voltage of more than 30 VAC or 60 VDC is to be applied to the output terminals, use ring-tongue crimp-on lugs with insulation sleeves on all terminals to prevent the wires from slipping out when the screws become loose. Furthermore, use double-insulated wires (dielectric strength of 2300 VAC or more) for the signal wires on which a voltage of more than 30 VAC or 60 VDC is to be applied. For all other wires, use basic insulated wires (dielectric strength of 1390 VAC). To prevent electric shock, attach the terminal cover after wiring and make sure not to touch the terminals.

CAUTION

- Use the following circuit voltage for the connection to the alarm/FAIL/status output terminal.
 - When the connection is to Mains Circuits (primary AC power source circuits): 150 V or less
 - When the connection is to circuits derived from Mains Circuits (secondary circuits): 250 V or less
(Mains Circuits voltage is less than 300 V, and connection must be used by isolation transformer.)
- To prevent fire, use signal wires having a temperature rating of 70°C or more.
- If a strong tension is applied to the cable wired to the DX, the terminals of the DX and/or the cable can be damaged. In order to prevent tension from being applied directly on the terminals, fasten all wiring cables to the rear of the mounting panel.
- Do not short the transmitter power supply output terminal or apply external voltage to it. If you do, the DX may malfunction.
- When using the transmitter power supply output terminal, do not use current that exceeds the maximum output current (25 mADC). If you do, the DX may malfunction.
- Do not short the VIDEO OUT terminal or apply external voltage to it. If you do, the DX may malfunction.

Note

For remote control wiring, use shielded wires to reduce noise. Connect the shield to the functional ground terminal or the ground terminal of the DX.

Precautions to Be Taken While Wiring

It is recommended that crimp-on lug with insulation sleeves (designed for 4-mm screws) be used when connecting wires to the optional input terminals.



Crimp-on lug with insulation sleeves (for 4 mm screws)

Wiring Procedure

As shown in the figure on next page, the optional terminal block is located on the rear panel. The optional terminal block is provided on the DX when an option that requires input/output is installed such as the alarm output relay (/A[] option), FAIL/status output relay (/F1 or /F2 option), and remote control function (/R1 option), etc. A terminal cover is screwed in place on the measuring input terminal block. A label indicating the terminal arrangement is affixed to the cover.

1. Turn OFF the DX and remove the terminal cover.
2. Connect the signal wires to the terminals.
3. Replace the terminal cover and fasten it with screws. The proper torque for tightening the screws is 0.6 N•m.

Arrangement of the Optional Terminals

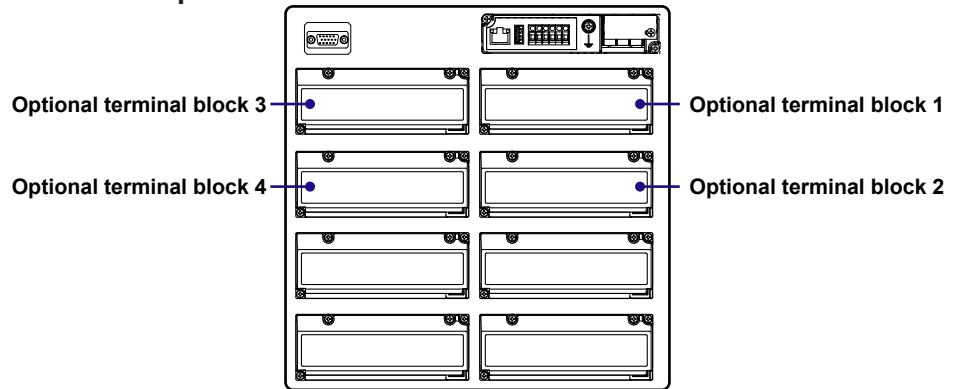

Description of Symbols

- NC** Symbols such as "NC": Terminal functions
 - Alarm output, FAIL/status output
 - NC**: Normally closed
 - C**: Common
 - NO**: Normally opened
- Remote control input
 - 1 to 8**: Terminal number
 - C**: Common
- Pulse input
 - H and L**: See page 61.
- Transmitter power supply
 - + and -**: See page 61.
- A terminal that is not used. (With a screw)
- A terminal that is not used. (Without screw)

Options That Use Option Terminal Block 1 Only

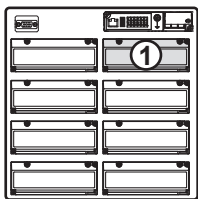

These options can come with /TPS4 or /TPS8. In that case, the option terminal block 4, or option terminal blocks 3 and 4 are installed. For the terminal arrangement for /TPS4 and /TPS8, see page 57.

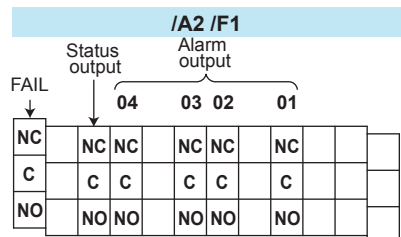
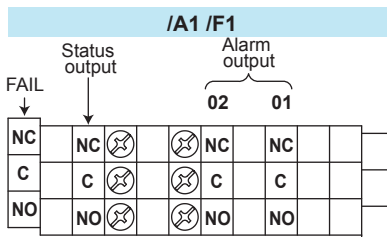
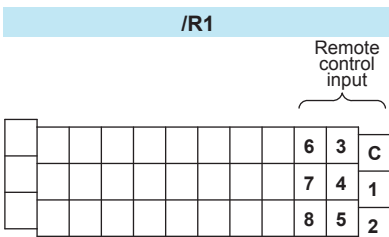
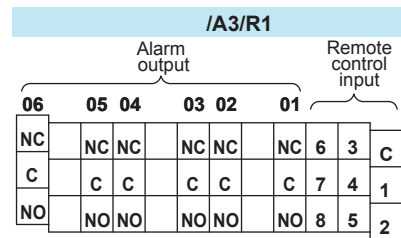
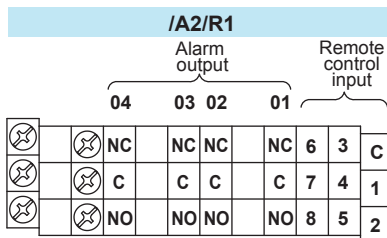
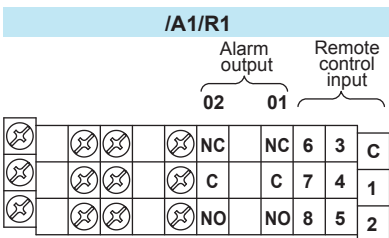
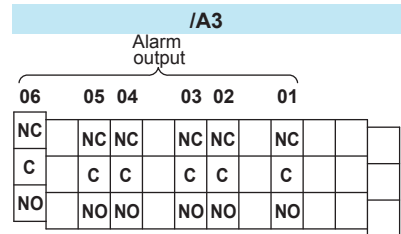
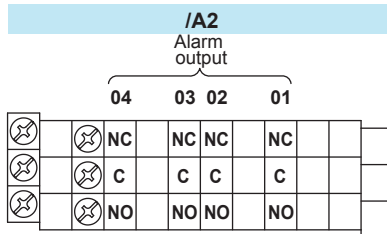
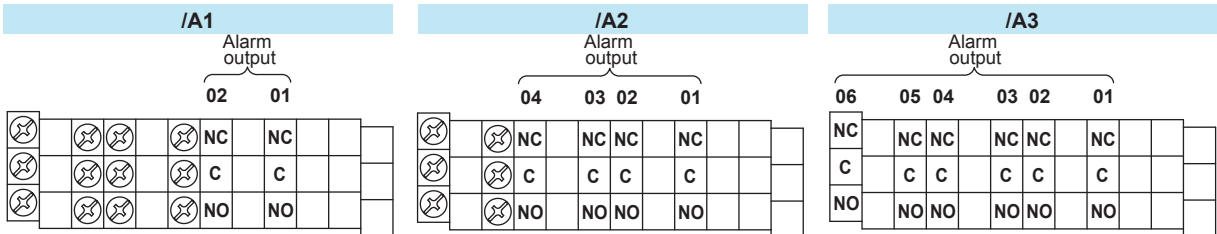

(To next page)

(From previous page)

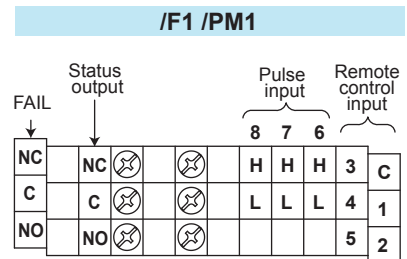
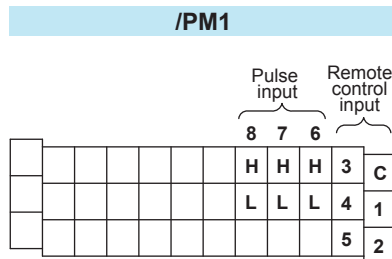
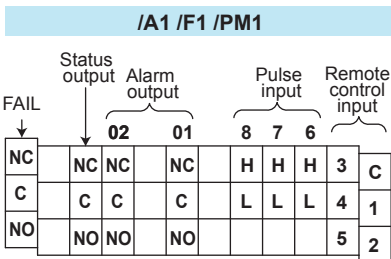
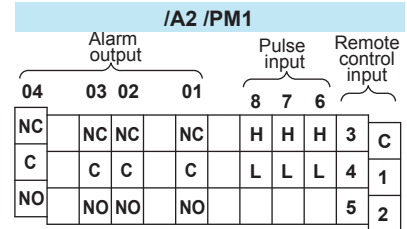
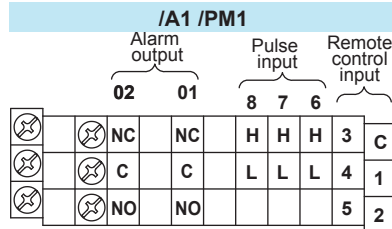
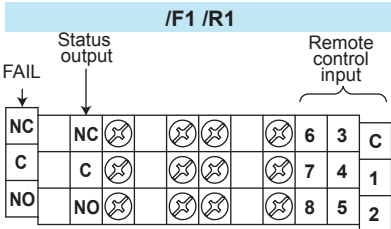
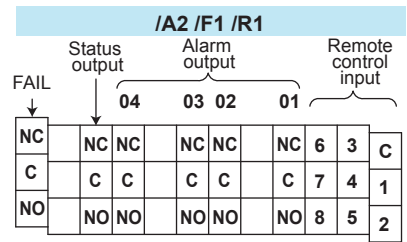
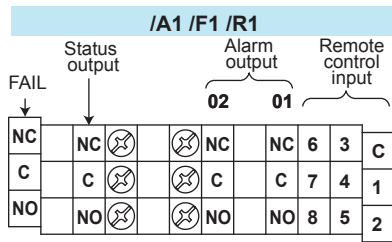
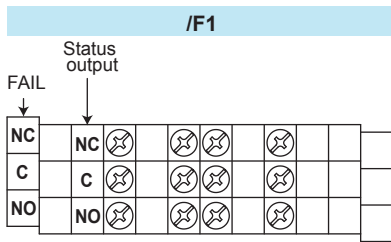

/TPS4

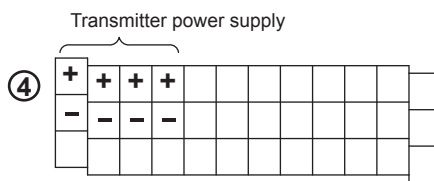
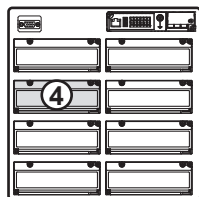

/TPS8

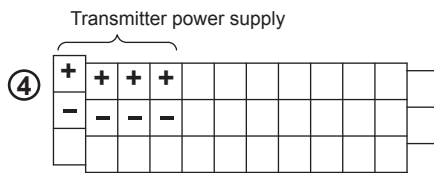
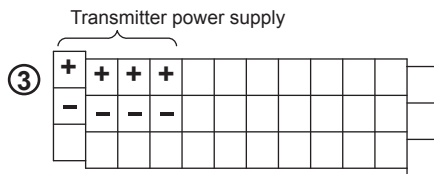
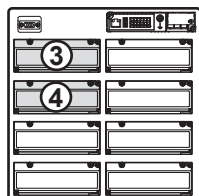

Options That Use Option Terminal Blocks 1, 2, and 3

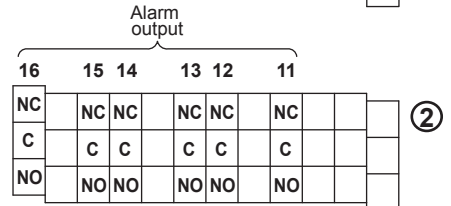
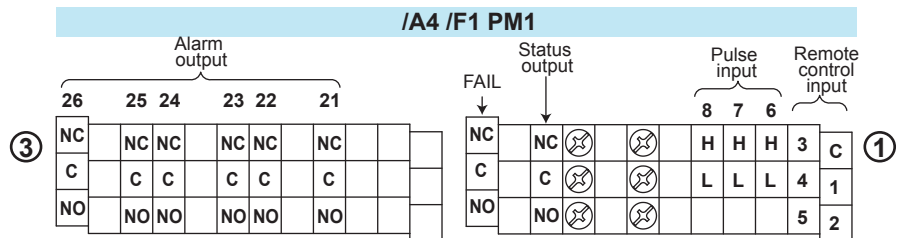
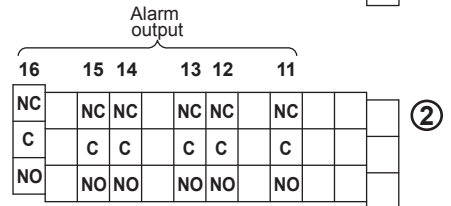
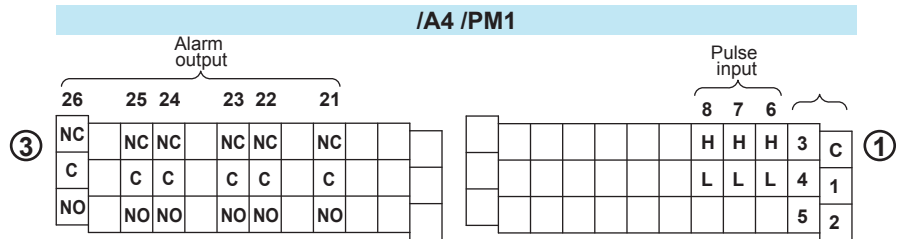
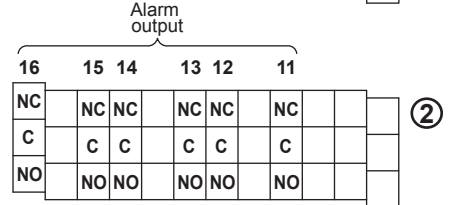
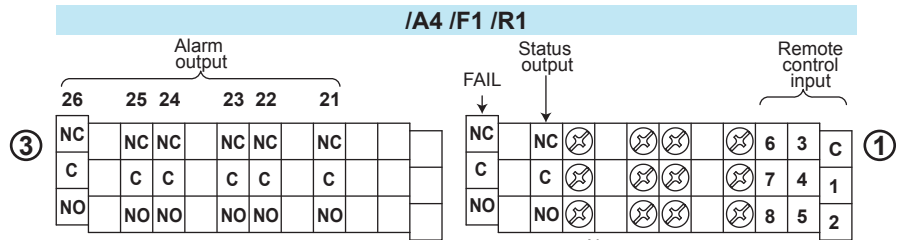
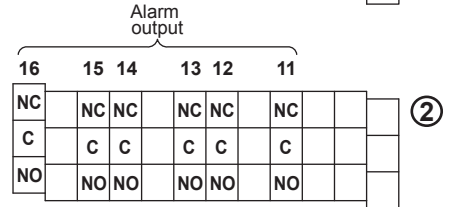
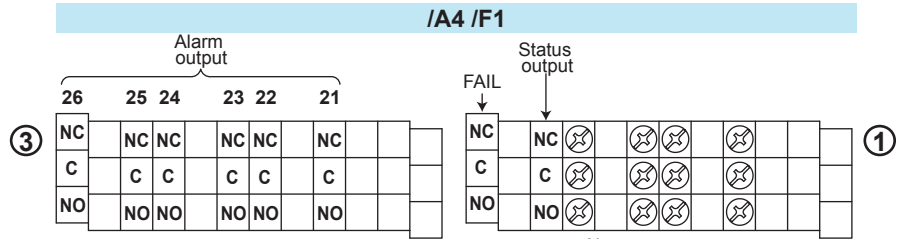
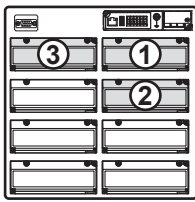

These options can come with /TPS4.
 In that case, the option terminal block 4 is installed.
 For the terminal arrangement for /TPS4, see page 57.

Options That Use Option Terminal Blocks 1, 2, 3, and 4

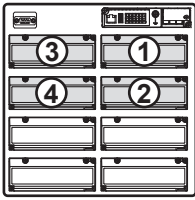

/A5

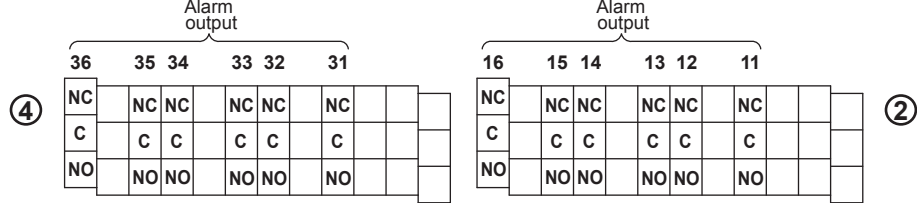
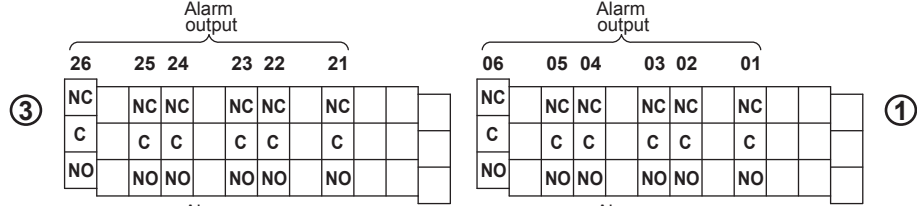

/A5 /R1

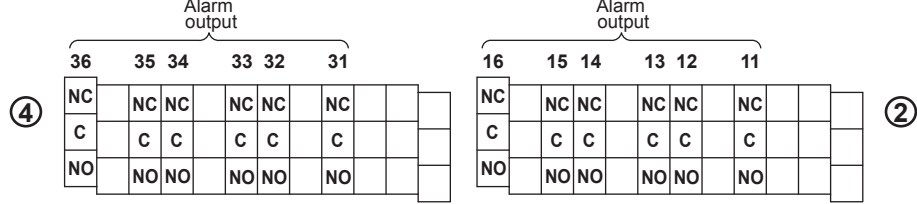
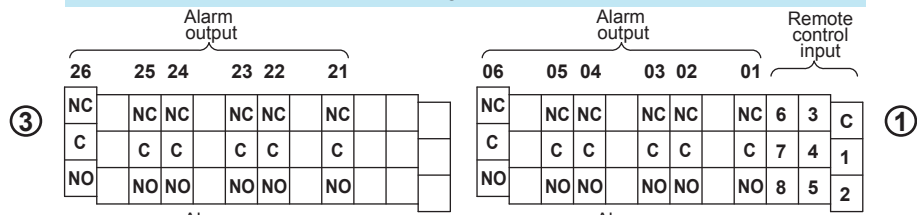

/F2

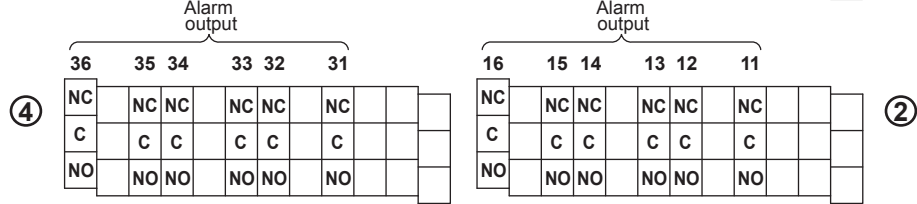
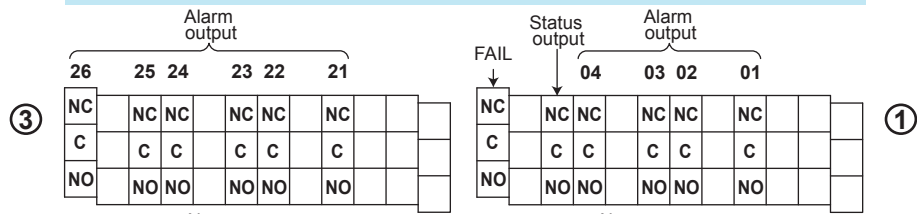

/F2 /R1

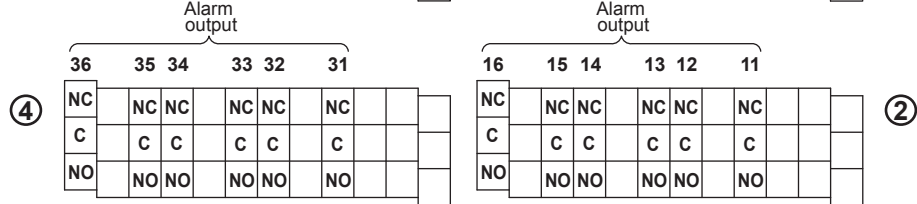
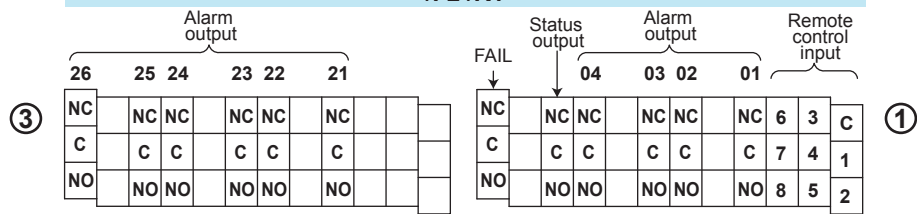

Alarm Output Terminal, FAIL Output Terminal, and Status Output Terminal (/A1, /A2, /A3, /A4, /A5, /F1, and /F2)

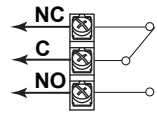

Output format: Relay contact
Contact rating: 250 VAC (50/60 Hz)/3 A, 250 VDC/0.1 A (for resistor load)
Withstand voltage: 1600 VAC at 50/60 Hz for one minute (between output terminals and the ground terminal)

Remote Control Input Terminal (/R1)

Relay contact input (voltage-free contact)
 Contact closed at 200 Ω
 Contact open at 100 kΩ or greater

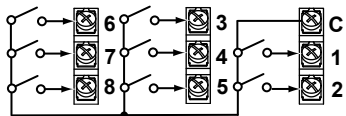

Transistor input (open collector)

ON voltage: 0.5 V or less (30 mADC)
 Leakage current when turned OFF: 0.25 mA or less

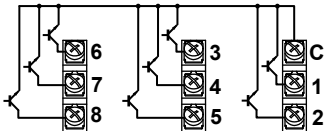

Withstand voltage: 1000 VDC for one minute between input terminals and the ground terminal

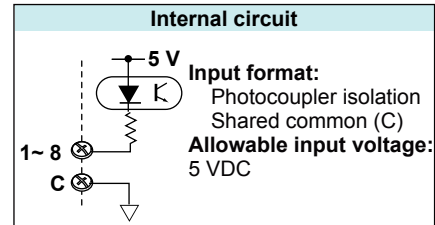

Pulse Input Terminal (/PM1)

Relay contact input (voltage-free contact)
 Contact closed at 200 Ω or less
 Contact open at 100 kΩ or greater

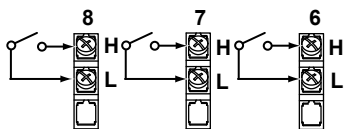

Transistor input (open collector)

ON voltage: 0.5 V or less (30 mADC)
 Leakage current when turned OFF: 0.25 mA or less

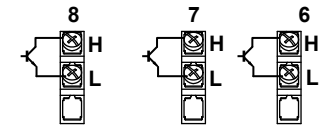

Withstand voltage: 1000 VDC for one minute between input terminals and the ground terminal

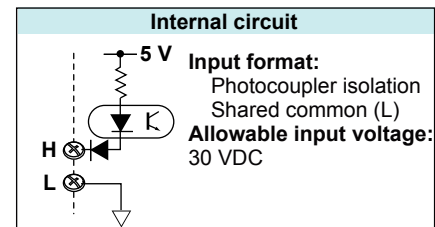

24 VDC Transmitter Power Supply Output Terminal (/TPS4 and /TPS8)

Connect the DX to the transmitter as shown below.

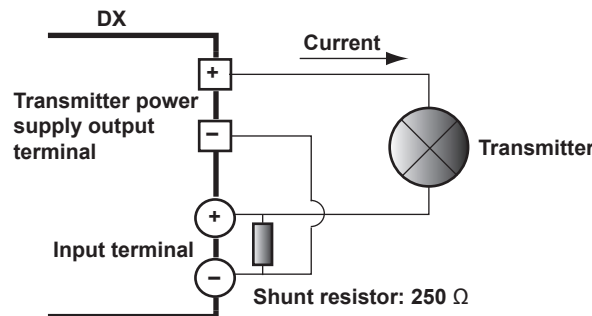

Note

To reduce noise, use a shielded cable for wiring. Connect the shield to the functional ground terminal or the ground terminal of the DX.

Serial Interface

Connecting to the RS-232 Connector (/C2)

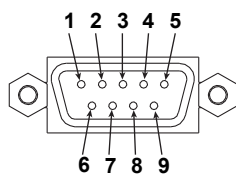

- 2 RD (Received Data): Received data from the PC. Input signal to the DX.
- 3 SD (Send Data): Transmitted data to the PC. Output signal from the DX.
- 5 SG (Signal Ground): Signal ground.
- 7 RS (Request to Send): Handshaking signal when receiving data from the PC. Output signal from the DX.
- 8 CS (Clear to Send): Handshaking signal when transmitting data to the PC. Input signal to the DX.

* Pins 1, 4, 6, and 9 are not used.

Connecting to the RS-422/485 (/C3)

Four-wire system

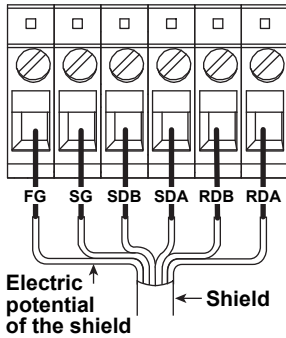

Two-wire system

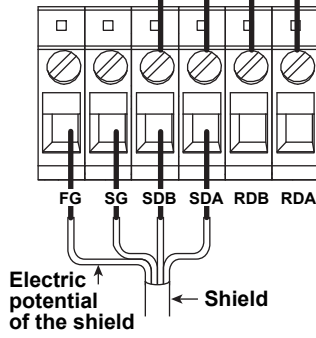

- FG (Frame Ground)** Frame ground of the DX.
- SG (Signal Ground)** Signal ground.
- SDB (Send Data B)** Send data B (+).
- SDA (Send Data A)** Send data A (-).
- RDB (Received Data B)** Receive data B (+).
- RDA (Received Data A)** Receive data A (-).

Recommended length of stripped wire: 9 mm. Recommended tightening torque: 0.4-0.5 N•m.

Cable

There are two types of cables available, the four-wire cable and the two-wire cable (used only for the Modbus protocol). The cable should meet the following specifications.

- Type: Shielded twisted pair cable: 3 pairs 24 AWG or more (four-wire),
2 pair 24 AWG or more (two-wire)
- Characteristic impedance: 100 Ω
- Capacitance: 50 pF/m
- Total cable length: Up to 1.2 km

Connecting to the VGA Connector (/D5)



CAUTION

- Connect the cable after turning OFF the DX and the monitor.
- Do not short the VIDEO OUT terminal or apply external voltage to it. If you do, the DX may malfunction.

VGA Output Terminal

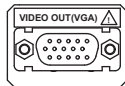

The DX display can be output to a monitor through the RGB output. Connectable monitors are VGA monitors or multi-sync monitors capable of displaying VGA.

Specifications of the VGA Output Terminal

| Pin No. | Signal Name | Specifications |
|---------|------------------------|--------------------------------------|
| 1 | Red | 0.7 Vp-p |
| 2 | Green | 0.7 Vp-p |
| 3 | Blue | 0.7 Vp-p |
| 4 | — | |
| 5 | — | |
| 6 | GND | |
| 7 | GND | |
| 8 | GND | |
| 9 | — | |
| 10 | GND | |
| 11 | — | |
| 12 | — | |
| 13 | Horizontal sync signal | Approx. 31.5 kHz, TTL negative logic |
| 14 | Vertical sync signal | Approx. 60 Hz, TTL negative logic |
| 15 | — | |

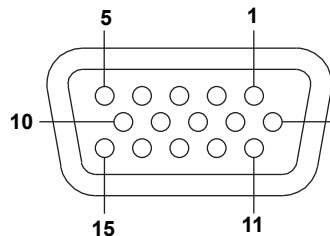

D-Sub 15-pin receptacle

Connecting to the Monitor

1. Turn OFF the DX and the monitor.
2. Connect the DX and the monitor using an analog RGB cable.
3. Turn ON the power to both the DX and the monitor. The DX screen is displayed on the monitor.

Note

- When the DX is turned ON, a VGA signal is always output from the VIDEO OUT terminal.
- The monitor screen may flicker if the DX or another instrument is brought close to the monitor.
- The edge of the screen may drop out depending on the monitor type.

Connecting to the USB Port (/USB1)

The USB port complies with Rev. 1.1.

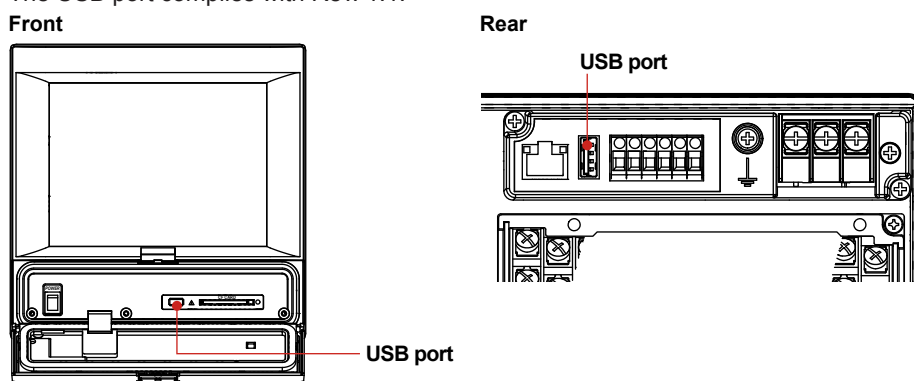

Connecting to the Ethernet Port

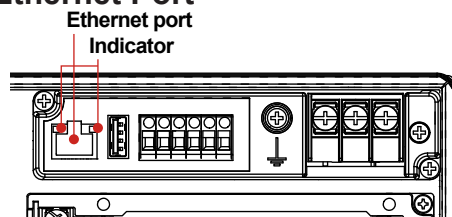

Checking the Connection/Communication Status

The connection status of the Ethernet interface can be confirmed with the indicator that is located to the upper right of the Ethernet connector of the DX.

| Indicator | Connection Status of the Ethernet Interface |
|---------------------|---|
| Illuminated (green) | The Ethernet interface is electrically connected. |
| Blinking (red) | Transmitting data. |
| Off | The Ethernet interface is not electrically connected. |

Checking the Connection on the DX Display

- **Checking the Connection at the status indication section of the DX display**
You can check the connection status of the Ethernet interface on the Ethernet Link indicator located on the right side of the status indication section of the basic setting mode display. The basic setting menu appears by pressing **MENU** to display the setting menu followed by **FUNC** for approximately 3 s.
- **Checking the Connection Status in the Display Section in the Upper Right Corner of the Communication Log Display of the DX**
You can check the connection status of the Ethernet interface on the Link indicator on the display section in the upper right corner of the communication log display.

| Indicator | Connection Status of the Ethernet Interface |
|---------------------|---|
| Illuminated (green) | The Ethernet interface is electrically connected. |
| Off | The Ethernet interface is not electrically connected. |

Power Supply Wiring

Panel Mount Type, or Desktop Type with /P1 Option (Models with /H5 and /P1 Options)

Precautions to Be Taken While Wiring the Power Supply

Make sure to follow the warnings below when wiring the power supply. To prevent electric shock and damage to the DX, observe the following warnings.



WARNING

- To prevent electric shock when wiring, ensure the main power supply is turned OFF.
 - To prevent the possibility of fire, use 600 V PVC insulated wire (AWG20 to 16) or an equivalent wire for power wiring.
 - Make sure to earth ground the protective earth terminal through a grounding resistance less than 100 Ω before turning ON the power.
 - Use crimp-on lug with insulation sleeves (for 4-mm screws) for power supply wires and protective grounding wires.
 - To prevent electric shock, make sure to close the transparent cover for the power supply wires.
 - Make sure to provide a power switch (double-pole type) on the power supply line in order to separate the DX from the main power supply. Put an indication on this switch as the breaker on the power supply line for the DX and indications of ON and OFF.
- Switch specifications
- Steady-state current rating: 1 A or more (other than /P1), 3 A or more (/P1).
 - Inrush current rating: 60 A or more (other than /P1), 70 A or more (/P1).
 - Use a switch complies with IEC60947-1, 3.
- Connect a fuse (between 2 A and 15 A) to the power line. Use a fuse approved by CSA (for the use in North America) or VDE (for the use in Europe).
 - Do not add a switch or fuse to the ground line.

Use a power supply that meets the following conditions:

| Item | Other than /P1 | /P1 |
|--|------------------------------|-------------------------------|
| Rated supply voltage | 100 to 240 VAC | 24 VDC/AC |
| Allowable power supply voltage range | 90 to 132/180 to 264 VAC | 21.6V to 26.4 VDC/AC |
| Rated power supply frequency | 50/60 Hz | 50/60 Hz (for AC) |
| Allowable power supply frequency range | 50/60 Hz ± 2% | 50/60 Hz±2% (for AC) |
| Maximum power consumption | 74 VA (100 V)/100 VA (240 V) | 45 VA (for DC), 70VA (for AC) |

Note

Do not use a supply voltage in the range 132 to 180 VAC, as this may have adverse effects on the measurement accuracy.

Wiring Procedure

1. Turn OFF the power to the DX and open the transparent power terminal cover.
2. Wire the power cord and the protective ground cord to the power supply terminals. Use ring-tongue crimp-on lugs (designed for 4 mm screws). The proper torque for tightening the screw is 1.4 to 1.5 N•m (12.4 to 13.2 inch•lbs).

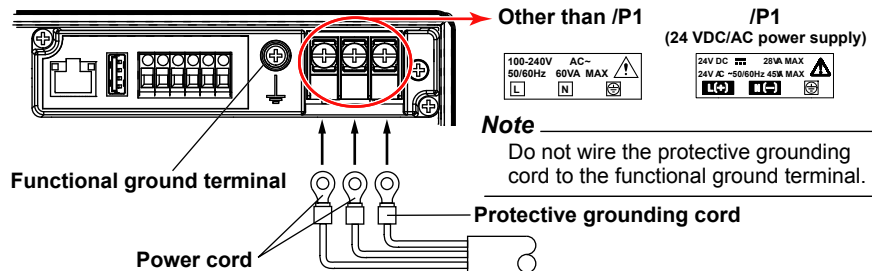

Note
Do not wire the protective grounding cord to the functional ground terminal.

3. Replace the power terminal cover, and fasten it with screws.

Desktop Type

Precautions to Be Taken While Connecting the Power Supply

Make sure to follow the warnings below when connecting the power supply. To prevent electric shock and damage to the DX, observe the following warnings.



WARNING

- Before connecting the power cord, ensure that the source voltage matches the rated supply voltage of the DX and that it is within the maximum rated voltage range of the provided power cord.
- Connect the power cord after checking that the power switch of the DX is turned OFF.
- To prevent electric shock or fire, be sure to use the power cord supplied by YOKOGAWA.
- Make sure to perform protective earth grounding to prevent electric shock. Connect the power cord of the desktop type to a three-prong power outlet with a protective earth terminal.
- Do not use an extension cord without protective earth ground. Otherwise, the protection function will be compromised.

Use a power supply that meets the following conditions:

| Item | Condition |
|--|---------------------------------|
| Rated supply voltage | 100 to 240 VAC |
| Allowable power supply voltage range | 90 to 132, 180 to 264 VAC |
| Rated power supply frequency | 50/60 Hz |
| Allowable power supply frequency range | 50/60 Hz \pm 2% |
| Maximum power consumption | 74 VA (100V) and 100 VA (240 V) |

Note

Do not use a supply voltage in the range 132 to 180 VAC, as this may have adverse effects on the measurement accuracy.

Connection Procedure

1. Check that the power switch is OFF.
2. Connect the power cord plug to the power connector on the rear panel. (Use the power cord that comes with the package.)

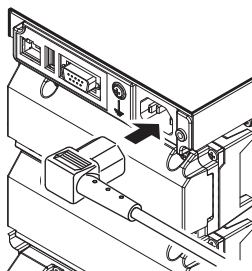

3. Check that the power outlet meets the conditions given in the table above and that the supply voltage is within the maximum rated voltage range of the power cord that comes with the package. Then, connect the other end of the power cord to the power outlet. The AC outlet must be of a three-prong type with a protective earth ground.

Recommended Replacement Periods for Worn Parts Maintenance

To preserve the reliability of the DX and to use the DX in a good condition for an extended time, it is recommended that periodic replacements be made on parts. The replacement parts may change to accommodate preventive maintenance over extended time. Be sure to check with your nearest YOKOGAWA dealer.

The following table shows the recommended replacement period for expendable parts. The replacement period shown here applies when the recorder is used under standard operating conditions. For the actual replacement period, consider the actual conditions of use. Replacement of parts will be carried out by a YOKOGAWA engineer or an engineer certified by YOKOGAWA. Contact your nearest YOKOGAWA dealer when such replacement is necessary.

| Item | Replacement period | Name | Part No. | Quantity Used | Notes |
|---------------------------------|--------------------|-----------------------|----------------------|---------------|-------------------------|
| LCD | 5 years | Back Light Unit | B9968PA | 1 | |
| Battery | 10 years | Battery Assembly | B9900BR | 1 | |
| Dust and water proof strip | 5 years | Packing | B8706FY | 1 | |
| | 5 years | Key Case Assembly | B8706BM | 1 | English specifications |
| | 5 years | Key Case Assembly | B8706BY | 1 | Japanese specifications |
| Aluminum electrolytic capacitor | 5 years* | Power Supply Assembly | – | 1 | |
| | 5 years* | AD Assembly | Depends on the model | | |

* Replacement period at the upper limit of the normal operating temperature (50°C)
 The replacement period varies depending on the operating temperature and the specifications of the DX.
 The lower the operating temperature, the longer is the replacement period. For example, if the operating temperature is 30°C, it may be possible to use the parts for more than 10 years.

Note

- The LCD replacement period indicates the half life of the brightness when the brightness is set to the factory default setting. The half life is shortened as the brightness is set higher. The deterioration of brightness varies depending on the condition of use, and its determination is subjective. Consider these facts for determining the actual replacement period.
- The color of the LCD may become yellowish as time elapses. The discoloration tends to progress faster as the brightness is set higher.

Setup Items and Default Values

The setup items and the default values in the setting mode are listed below. Enter the settings that you are using in the Setting column for your convenience.

Setting mode menu

| Setting menu | |
|------------------------|-----------------|
| Date/Time ● | Page 68 |
| Meas channel ● | Page 68 to 70 |
| Math channel ● | Page 71 and 72* |
| Ext. channel ● | Page 73* |
| Display ● | Page 74 |
| Group set, Trip line ● | Page 74 |
| Message ● | Page 74 |
| Timer, Event action ● | Page 75 |
| Data save ● | Page 76 |
| Save/Load ● | Page 76 |
| Menu customize ● | Page 76 |

*: Options

Basic setting mode menu

| Basic Setting Mode | |
|-----------------------------|----------------------|
| Setting menu | |
| Alarm ● | Page 77 |
| A/D, Memory ● | Page 77 |
| Burnout, RJC ● | Page 77 |
| Environment ● | Page 77 and 78 |
| Keylock ● | Page 78 ² |
| Log in ● | Page 79 ² |
| Report ● | Page 79 ¹ |
| Time settings ● | Page 79 |
| Load settings, Initialize ● | Page 79 |
| Communication (Ethernet) ● | Page 80 and 82 |
| Communication (Serial) ● | Page 82 ¹ |
| Status relay ● | Page 83 |
| End ● | Page 83 |

1: Options

2: Displayed when the function is enabled in the **Environment** settings.

Setup Items in Setting Mode and Their Default Values

Date/Time > Time settings

| Setup Item | Selectable Range or Selections | Default Value | Setting |
|------------|--------------------------------|---------------|---------|
| Time set | – | – | |

Date/Time > Daylight Saving Time

| Setup Item | Selectable Range or Selections | Default Value | Setting |
|------------------------------|---|---------------|---------|
| Use/Not | Use/Not | Not | |
| Start time > Month | JAN/FEB/MAR/APR/MAY/JUN/JUL/AUG/SEP/OCT/NOV/DEC | APR | |
| Start time > Day order | 1st/2nd/3rd/4th/Last | 1st | |
| Start time > Day of the week | SUN/MON/TUE/WED/THU/FRI/SAT | SUN | |
| Start time > Hour of the day | Numerical value | 2 | |
| End time > Month | JAN/FEB/MAR/APR/MAY/JUN/JUL/AUG/SEP/OCT/NOV/DEC | OCT | |
| End time > Day order | 1st/2nd/3rd/4th/Last | Last | |
| End time > Day of the week | SUN/MON/TUE/WED/THU/FRI/SAT | SUN | |
| End time > Hour of the day | Numerical value | 1 | |

Meas channel > Range, Alarm

| Setup Item | Selectable Range or Selections | Default Value | Setting |
|-------------------|---|---------------|---------|
| First-CH, Last-CH | Channel number | | |
| Range > Mode | Skip/Volt/TC/RTD/Scale/Delta/DI/1-5V/Sqrt | Volt | |
| Mode=Volt | | | |
| Range | 20mV/60mV/200mV/2V/6V/20V/50V | 2V | |
| Span Lower | Depends on the range. | – | |
| Span Upper | Depends on the range. | – | |
| Mode=TC | | | |
| Range | R/S/B/K/E/J/T/N/W/L/U/WRe | R | |
| Span Lower | Depends on the range. | – | |
| Span Upper | Depends on the range. | – | |
| Mode=RTD | | | |
| Range | Pt/JPt | Pt | |
| Span Lower | Depends on the range. | – | |
| Span Upper | Depends on the range. | – | |
| Mode=Scale | | | |
| Type | Volt/TC/RTD/DI | Volt | |
| Range | Depends on the type. | – | |
| Span Lower | Depends on the range. | – | |
| Span Upper | Depends on the range. | – | |
| Scale Lower | –30000 to 30000, decimal position: 0 to 4 | 0.00 | |
| Scale Upper | –30000 to 30000, decimal position: 0 to 4 | 200.00 | |
| Unit | 6 characters or less | | |
| Mode=Delta | | | |
| Type | Volt/TC/RTD/DI | Volt | |
| Range | Depends on the type. | – | |
| Span Lower | Depends on the range. | – | |
| Span Upper | Depends on the range. | – | |
| Ref.CH | Meas channel number | – | |
| Mode=DI | | | |
| Range | Level/Cont | Level | |
| Span Lower | 0, 1 | 0 | |
| Span Upper | 0, 1 | 1 | |

| Setup Item | Selectable Range or Selections | Default Value | Setting |
|------------------|--|---------------|---------|
| Mode=1-5V | | | |
| Range | 1-5V | 1-5V | |
| Span Lower | 0.800 to 5.200 | 1.000 | |
| Span Upper | 0.800 to 5.200 | 5.000 | |
| Scale Lower | -30000 to 30000, decimal position :0 to 4 | 0.00 | |
| Scale Upper | -30000 to 30000, decimal position :0 to 4 | 200.00 | |
| Unit | 6 characters or less | - | |
| Low-cut | On/Off | Off | |
| Mode=Sqrt | | | |
| Range | 20mV/60mV/200mV/2V/6V/20V/50V | | |
| Span Lower | Depends on the range. | - | |
| Span Upper | Depends on the range. | - | |
| Scale Lower | -30000 to 30000, decimal position: 0 to 4 | 0.00 | |
| Scale Upper | -30000 to 30000, decimal position: 0 to 4 | 200.00 | |
| Unit | 6 characters or less | - | |
| Low-cut | On/Off | Off | |
| Low-cut value | 0.0 to 5.0 | 0.5 | |
| Alarm | | | |
| 1, 2, 3, 4 | On/Off | Off | |
| Type | H:High/L:Low/h:delta H/l:delta L/R:rate H/ r:rate L/T:delayH/t:delayL | H | |
| Value | Numerical value | - | |
| Relay | On/Off | Off | |
| Number | I01/.../I06, I11/.../I16, I21/.../I26, I31/.../I36 (Depends on the model.) S01/S02/S03/.../S29/S30 | I01 | |
| Detect | On/Off | On | |

Meas channel > Tag, Memory sample, Alarm delay

| Setup Item | Selectable Range or Selections | Default Value | Setting |
|------------------------|--------------------------------|---------------|---------|
| First-CH, Last-CH | Channel number | 1 | |
| Tag > Tag | 16 characters or less | - | |
| Memory sample > On/Off | On/Off | On | |
| Alarm delay > Time | 1 to 3600 | 10 | |

Meas channel > Moving average

| Setup Item | Selectable Range or Selections | Default Value | Setting |
|-------------------------|--------------------------------|---------------|---------|
| First-CH, Last-CH | Channel number | 1 | |
| Moving average > On/Off | On/Off | Off | |
| Moving average > Count | 2 to 400 | 2 | |

Meas channel > Color

| Setup Item | Selectable Range or Selections | Default Value | Setting |
|------------------|---|-----------------------|---------|
| Group of channel | 001-010, etc | Depends on the model. | |
| Color | Red/Green/Blue/B.violet/Brown/Orange/ Y.green/Lightblue/Violet/Graly/Lime/Cyan/ Darkblue/Yellow/Lightgray/Purple/Black/Pink/ L.brown/L.green/Darkgray/Olive/DarkCyan/ S.green (24 colors) | Red to Gray | |

Setup Items and Default Values

Meas channel > Zone, Scale, Bar graph

| Setup Item | Selectable Range or Selections | Default Value | Setting |
|---------------------------|--------------------------------|---------------|---------|
| First-CH, Last-CH | Channel number | 1 | |
| Zone > Lower | 0 to 95 | 0 | |
| Zone > Upper | 5 to 100 | 100 | |
| Scale > Position | Off/1/2/3/4/5/6/7/8/9/10 | 1 | |
| Scale > Division | 4/5/6/7/8/9/10/11/12/C10 | 10 | |
| Bar graph > Base position | Normal/Center/Lower*/Upper* | Normal | |
| Bar graph > Division | 4/5/6/7/8/9/10/11/12 | 10 | |

* A function available on DXs with release number 2 or later.

Meas channel > Partial

| Setup Item | Selectable Range or Selections | Default Value | Setting |
|-------------------|--|---------------|---------|
| First-CH, Last-CH | Channel number | 1 | |
| On/Off | On/Off | Off | |
| Expand | 1 to 99% | 50 | |
| Boundary | Span Lower+1digit to Span Upper-1digit | 0.0000 | |

Meas channel > Alarm mark, Color scale band

| Setup Item | Selectable Range or Selections | Default Value | Setting |
|---|-----------------------------------|---------------|---------|
| First-CH, Last-CH | Channel number | 1 | |
| Alarm mark > Mark kind | Alarm/Fixed | Alarm | |
| Alarm mark > Indicate on Scale | On/Off | Off | |
| Alarm mark > Alarm mark color > Alarm 1 | Red/Green/.../S.green (24 colors) | Red | |
| Alarm mark > Alarm mark color > Alarm 2 | Same as Alarm 1 | Orange | |
| Alarm mark > Alarm mark color > Alarm 3 | Same as Alarm 1 | Orange | |
| Alarm mark > Alarm mark color > Alarm 4 | Same as Alarm 1 | Red | |
| Color scale band > Band area | Off/In/Out | Off | |
| Color scale band > Color | Red/Green/.../S.green (24 colors) | Lime | |
| Color scale band > Display position > Lower | Measuring range | 0.0000 | |
| Color scale band > Display position > Upper | Measuring range | 0.0100 | |

Meas channel > Calibration correction

| Setup Item | Selectable Range or Selections | Default Value | Setting |
|----------------------|---|---------------|---------|
| First-CH, Last-CH | Channel number | 1 | |
| Number of set points | Off/2/3/4/5/6/7/8/9/10/11/12/13/14/15/16 | Off | |
| 1 to n > MES val | Value in the measuring range/measured value | - | |
| 1 to n > True val | Measuring range | - | |

Math channel > Calculation expression, Alarm

| Setup Item | Selectable Range or Selections | Default Value | Setting |
|-------------------------------------|---|---------------|---------|
| First-CH, Last-CH | Channel number | 101 | |
| Math range > Math On/Off | On/Off | Off | |
| Math range > Calculation expression | 120 characters or less | – | |
| Math range > Span Lower | –9999999 to 99999999, decimal position: 0 to 4 | –200.00 | |
| Math range > Span Upper | –9999999 to 99999999, decimal position: 0 to 4 | 200.00 | |
| Math range > Unit | 6 characters or less | – | |
| Math alarm | | | |
| 1, 2, 3, 4 | On/Off | Off | |
| Type | H:High/L:Low/T:delayH/t:delayL | – | |
| Value | Numerical value | – | |
| Relay On/Off | On/Off | Off | |
| Number | I01/.../I06, I11/.../I16, I21/.../I26, I31/.../I36 (Depends on the model.) | I01 | |
| Detect | S01/S02/S03/.../S29/S30 | On | |

Math channel > Constant

| Setup Item | Selectable Range or Selections | Default Value | Setting |
|--------------------|---|---------------|---------|
| Number of constant | K01 to K60 | K01 | |
| Value | –9.9999E+29 to –1.0000E–30, 0, 1.0000E–30 to –9.9999E+29 | 1 | |

Math channel > Tag, Memory sample, Alarm delay

| Setup Item | Selectable Range or Selections | Default Value | Setting |
|------------------------|--------------------------------|---------------|---------|
| First-CH, Last-CH | Channel number | 101 | |
| Tag > Tag | 16 characters or less | – | |
| Memory sample > On/Off | On/Off | On | |
| Alarm delay > Time | 1 to 3600 | 10 | |

Math channel > TLOG, Rolling average

| Setup Item | Selectable Range or Selections | Default Value | Setting |
|-------------------------------------|--|---------------|---------|
| First-CH, Last-CH | Channel number | 101 | |
| TLOG > Timer No. | 1/2/3/4 | 1 | |
| TLOG > Sum scale | Off, /s, /min, /h | Off | |
| TLOG > Reset | On/Off | Off | |
| Rolling average > On/Off | On/Off | Off | |
| Rolling average > Interval | 1s/2s/3s/4s/5s/6s/10s/12s/15s/20s/30s/ 1min/2min/3min/4min/5min/6min/10min/12min/ 15min/20min/30min/1h | 10s | |
| Rolling average > Number of samples | 1 to 1500 | 1 | |

Math channel > Color

| Setup Item | Selectable Range or Selections | Default Value | Setting |
|------------------|-----------------------------------|-----------------------|---------|
| Group of channel | 101-110, etc | Depends on the model. | |
| Color | Red/Green/.../S.green (24 colors) | Red to Gray | |

Math channel > Zone, Scale, Bar graph

Same as Meas channel.

Setup Items and Default Values

Math channel > Partial

| Setup Item | Selectable Range or Selections | Default Value | Setting |
|-------------------|--|---------------|---------|
| First-CH, Last-CH | Channel number | 101 | |
| On/Off | On/Off | Off | |
| Expand | 1 to 99% | 50 | |
| Boundary | Span Lower+1digit to Span Upper-1digit | 0.00 | |

Math channel > Alarm mark, Color scale band

| Setup Item | Selectable Range or Selections | Default Value | Setting |
|---|-----------------------------------|---------------|---------|
| First-CH, Last-CH | Channel number | 101 | |
| Alarm mark > Mark kind | Alarm/Fixed | Alarm | |
| Alarm mark > Indicate on Scale | On/Off | Off | |
| Alarm mark > Alarm mark color > Alarm 1 | Red/Green/.../S.green (24 colors) | Red | |
| Alarm mark > Alarm mark color > Alarm 2 | Same as Alarm 1 | Orange | |
| Alarm mark > Alarm mark color > Alarm 3 | Same as Alarm 1 | Orange | |
| Alarm mark > Alarm mark color > Alarm 4 | Same as Alarm 1 | Red | |
| Color scale band > Band area | Off/In/Out | Off | |
| Color scale band > Color | Red/Green/.../S.green (24 colors) | Lime | |
| Color scale band > Display position > Lower | Measuring range | 0.00 | |
| Color scale band > Display position > Upper | Measuring range | 1.00 | |

Math channel > Math start action

| Setup Item | Selectable Range or Selections | Default Value | Setting |
|--------------------------------|--------------------------------|---------------|---------|
| Math start action > Math start | Off/Start/Rst+St | Start | |

Ext. channel > Range, Alarm

| Setup Item | Selectable Range or Selections | Default Value | Setting |
|-------------------------|---|---------------|---------|
| First-CH, Last-CH | Channel number | 201 | |
| Ext. range > On/Off | On/Off | Off | |
| Ext. range > Span Lower | -30000 to 30000, decimal position: 0 to 4 | -200.00 | |
| Ext. range > Span Upper | -30000 to 30000, decimal position: 0 to 4 | 200.00 | |
| Ext. range > Unit | 6 characters or less | - | |
| Ext. alarm | | | |
| 1, 2, 3, 4 | On/Off | Off | |
| Type | H:High/L:Low/T:delayH/t:delayL | - | |
| Value | Numerical value | - | |
| Relay On/Off | On/Off | Off | |
| Number | I01/.../I06, I11/.../I16, I21/.../I26, I31/.../I36 (Depends on the model.) | I01 | |
| Detect | S01/S02/S03/.../S29/S30 | On | |

Ext. channel > Tag, Memory sample, Alarm delay

| Setup Item | Selectable Range or Selections | Default Value | Setting |
|------------------------|--------------------------------|---------------|---------|
| First-CH, Last-CH | Channel number | 201 | |
| Tag > Tag | 16 characters or less | - | |
| Memory sample > On/Off | On/Off | On | |
| Alarm delay > Time | 1 to 3600 | 10 | |

Ext. channel > Color

| Setup Item | Selectable Range or Selections | Default Value | Setting |
|------------------|---|---------------|---------|
| Group of channel | 201-210/211-220/221-230/.../421-430/ 431-440 | 201-210 | |
| Color | Red/Green/.../S.green (24 colors) | Red to Gray | |

Ext. channel > Zone, Scale, Bar graph

Same as Meas channel.

Ext. channel > Partial, Alarm mark, Color scale band

Same as Math channel.

Setup Items and Default Values

Display > Trend (Circular)/Save interval

| Setup Item | Selectable Range or Selections | Default Value | Setting |
|---------------------------|---|---------------|---------|
| Trend/Save interval | | | |
| Trend interval [div] | 15s/30s/1min/2min/5min/10min/15min/20min/ 30min/1h/2h/4h/10h | 1min | |
| Save interval | 10min to 31 day (Depends on the trend interval.) | 1h | |
| Second interval [div] | 15s/30s/1min/2min/5min/10min/15min/20min/ 30min/1h/2h/4h/10h | 1min | |
| Circular/Save interval | | | |
| Time per revolution [rev] | 20min/30min/1h/2h/6h/8h/12h/16h/1day/ 2day/1week/2week/4week | 1day | |
| Save interval | 10min to 31 day (Depends on the time per revolution.) | 1h | |
| Offset time | Off/1h to 23h (Depends on the time per revolution.) | Off | |

Display > Trend (Circular), Bar graph, LCD, Monitor

| Setup Item | Selectable Range or Selections | Default Value | Setting |
|---|---|---------------|---------|
| Trend | | | |
| Trend > Direction | Horizontal/Vertical/Wide/Split | Horizontal | |
| Trend > Trend clear | On/Off | Off | |
| Trend > Message direction | Horizontal/Vertical | Horizontal | |
| Trend > Scale > Digit | Normal/Fine | Normal | |
| Trend > Scale > Value indicator | Mark/Bargraph | Mark | |
| Trend > Trend line | 1/2/3 | 2 | |
| Trend > Grid | Auto/4/5/6/7/8/9/10/11/12 | Auto | |
| Circular | | | |
| Circular > Full circle action | Allclear/Divclear | Allclear | |
| Circular > Trend line | 1/2/3 | 2 | |
| Circular > Grid | Auto/4/5/6/7/8/9/10/11/12 | Auto | |
| Bar graph > Direction | Horizontal/Vertical | Vertical | |
| LCD > Brightness | 1/2/3/4/5/6 | 2 | |
| LCD > Backlight saver > Mode | Off/Dimmer/Timeoff | Off | |
| LCD > Backlight saver > Saver time | 1min/2min/5min/10min/30min/1h | 1h | |
| LCD > Backlight saver > Restore | Key, Key+Alarm | Key+Alarm | |
| Monitor > Background > Display | White/Black | White | |
| Monitor > Background > Historical trend | White/Cream/Black/Lightgray | Black | |
| Monitor > Scroll time | 5s/10s/20s/30s/1min | 10s | |
| Monitor > Jump default display | Off/1min/2min/5min/10min/20min/30min/1h | Off | |

Group set, Trip line

| Setup Item | Selectable Range or Selections | Default Value | Setting |
|------------------------|---|--|---------|
| Group number | 1/2/3/.../35/36 | 1 | |
| Group set > On/Off | On/Off | Group 1 to 4: On Group 5 to 36: Off | |
| Group set > Group name | GROUP1 to GROUP36/16 characters or less | GROUP1 etc. | |
| Group set > CH set | 39 characters or less | Depends on the model. | |
| Trip line > 1 | On/Off | Off | |
| Trip line > 2 | On/Off | Off | |
| Trip line > 3 | On/Off | Off | |
| Trip line > 4 | On/Off | Off | |
| Trip line > Position | 0 to 100 | 50 | |
| Trip line > Color | Red/Green/.../S.green (24 colors) | 1:Red, 2:Green 3:Blue, 4:Yellow | |
| Trip line > Line width | 1/2/3 | 2 | |

Message

| Setup Item | Selectable Range or Selections | Default Value | Setting |
|------------------|---|---------------|---------|
| Message No. | 1-10/11-20/21-30/31-40/41-50/51-60/ 61-70/71-80/81-90/91-100 | 1-10 | |
| Message 1 to 100 | 32 characters or less | – | |

Timer, Event action > Timer

| Setup Item | Selectable Range or Selections | Default Value | Setting |
|--------------------------------|---|---------------|---------|
| Timer No. | 1/2/3/4 | 1 | |
| Mode | Off/Relative/Absolute | Off | |
| Relative > Interval | 00:01 to 24:00 | 01:00 | |
| Relative > Reset at Math Start | On/Off | On | |
| Absolute > Interval | 1min/2min/3min/4min/5min/6min/10min/ 12min/15min/20min/30min/1h/2h/3h/4h/ 6h/8h/12h/24h | 1h | |
| Absolute > Ref.time | 0 to 23 | 0:00 | |

Timer, Event action > Match time timer

| Setup Item | Selectable Range or Selections | Default Value | Setting |
|-----------------|--------------------------------|---------------|---------|
| Timer number | 1/2/3/4 | 1 | |
| Kind | Off/Day/Week/Month | Off | |
| Day | 1 to 28 | 1 | |
| Day of the week | SUN/MON/TUE/WED/THU/FRI/SAT | SUN | |
| Hour | 00:00 to 23:59 | 00:00 | |
| Timer action | Single/Repeat | Repeat | |

Timer, Event action > Event action

| Setup Item | Selectable Range or Selections | Default Value | Setting |
|---------------------------------------|---|---------------|---------|
| Logic box number | 1/2/3/.../39/40 | 1 | |
| Event | None/Remote/Relay/Switch/Timer/ Matchtime/Alarm/UserKey | None | |
| Remote > Remote number | 1/2/3/4/5/6/7/8 | 1 | |
| Relay > Relay number | I01/.../I06, I11/.../I16, I21/.../I26, I31/.../I36 (Depends on the model.) | I01 | |
| Switch > Switch No. | S01/S02/S03/.../S29/S30 | S01 | |
| Timer > Timer No. | 1/2/3/4 | 1 | |
| MatchTimeTimer > Match Time Timer No. | 1/2/3/4 | 1 | |
| Action | MemoryStart/Stop, MemoryStart, MemoryStop, Trigger, AlarmACK, MathStart/ Stop, MathStart, MathStop, MathReset, SaveDisplay, SaveEvent, Message, Snapshot, DisplayRate1/2, ManualSample, TimerReset, DisplayGroupChange, Flag, PanelLoad, TimeAdjust | Group | |
| Message > Message No. | 1 to 100 | 1 | |
| Message > Write to | All/Select | All | |
| Message > Group number | 1/2/3/.../35/36 | 1 | |
| Group > Group number | 1/2/3/.../35/36 | 1 | |
| Flag > Flag number | 1/2/3/4/5/6/7/8 | 1 | |
| TimerRst > Timer No. | 1/2/3/4 | 1 | |
| PnlLoad > Setting file number | 1/2/3 | 1 | |

Setup Items and Default Values

Data save > File header, Data file name

| Setup Item | Selectable Range or Selections | Default Value | Setting |
|-------------------------------------|--------------------------------|---------------|---------|
| File header > Characters | 50 characters or less | – | |
| Data file name > Structure | Date/Serial/Batch | Date | |
| Data file name > Identified strings | 16 characters or less | – | |

Data save > Save directory

| Setup Item | Selectable Range or Selections | Default Value | Setting |
|----------------|--------------------------------|---------------|---------|
| Directory name | 20 characters or less | DATA0 | |

Data save > Event data

| Setup Item | Selectable Range or Selections | Default Value | Setting |
|----------------------|--|---------------|---------|
| Sample rate | 25ms/125ms/250ms/500ms/1s/2s/5s/10s/ 30s/60s/120s/300s/600s (Depends on the model.) | 1s | |
| Mode | Free/Single/Repeat | Free | |
| Data length | 10min to 31day (Depends on the sample rate.) | 1h | |
| Pre-trigger | 0/5/25/50/75/95/100 | 0 | |
| Trigger signal > Key | On/Off | On | |

Data save > Manual sample

| Setup Item | Selectable Range or Selections | Default Value | Setting |
|----------------------|--------------------------------|---------------|---------|
| Manual sample number | 001 to 120 | 001 | |
| On/Off | On/Off | On | |
| Channel | Channel number | 001 | |

Data save > Batch text

| Setup Item | Selectable Range or Selections | Default Value | Setting |
|-----------------------------|--------------------------------|---------------|---------|
| Text field number | 1/2/3/4/5/6/7/8 | 1 | |
| Text field > Title of field | 20 characters or less | – | |
| Text field > Characters | 30 characters or less | – | |

Save/Load

| Setup Item | Selectable Range or Selections | Default Value | Setting |
|---------------------------|--------------------------------|---------------|---------|
| Load display data > Kind | CF/USB | CF | |
| Load event data > Kind | CF/USB | CF | |
| Load settings > Kind | CF/USB | CF | |
| Save settings > Kind | CF/USB | CF | |
| Save settings > File name | 32 characters or less | – | |
| File list/delete > Kind | CF/USB | CF | |
| Format > Kind | CF/USB | CF | |
| Format > Volume name | 11 characters or less | – | |

Menu customize

| Setup Item | Selectable Range or Selections | Default Value | Setting |
|---------------|------------------------------------|---------------|---------|
| Function menu | Select/Hide/View/Transfer | – | |
| Display menu | Separate/Select/Hide/View/Transfer | – | |

Setup Items in Basic Setting Mode and Their Default Values

Alarm

| Setup Item | Selectable Range or Selections | Default Value | Setting |
|------------------------------|--------------------------------------|---------------|---------|
| Basic setting | | | |
| Reflash | On/Off | Off | |
| Rate of change > Decrease | 1 to 32 | 1 | |
| Rate of change > Increase | 1 to 32 | 1 | |
| Indicator | Hold/Nonhold | Nonhold | |
| Switch, Relay | | | |
| Internal Switch > AND | None/S01/S01-S02/.../S01-S29/S01-S30 | None | |
| Relay > AND | None/I01/I01-I02/.../I01-I35/I01-I36 | None | |
| Relay > Action | Energize/De_energ | Energize | |
| Relay > Hold | Hold/Nonehold | Nonhold | |
| Relay > Relay Action on ACK* | Normal/Reset | Normal | |
| Hysteresis | | | |
| Meas CH > High/Low | 0.0 to 5.0 | 0.5 | |
| Meas CH > Delta High/Low | 0.0 to 5.0 | 0.0 | |
| Math CH > High/Low | 0.0 to 5.0 | 0.0 | |
| Ext. CH > High/Low | 0.0 to 5.0 | 0.0 | |

* A function available on DXs with release number 2 or later.

A/D, Memory

| Setup Item | Selectable Range or Selections | Default Value | Setting |
|---------------------------|--|---------------|---------|
| Scan interval > Scan mode | | | |
| Normal > Scan interval | Normal/Fast | Normal | |
| | 125ms/250ms(DX2004, DX2008) | 125ms | |
| | 1s/2s/5s(DX2010, DX2020, DX2030, DX2040, DX2048) | 1s | |
| Normal > A/D integrate | Auto/50Hz/60Hz/100ms | Auto | |
| Fast > Scan interval | 25ms (DX2004, DX2008) | 25ms | |
| | 125ms (DX2010, DX2020, DX2030, DX2040, DX2048) | 125ms | |
| Fast > A/D integrate | 600Hz | 600Hz | |
| Memory > Data kind | Display/E+D/Event | Display | |

Burnout, RJC

| Setup Item | Selectable Range or Selections | Default Value | Setting |
|--------------------|--------------------------------|---------------|---------|
| First-CH, Last-CH | Channel number | – | |
| Burnout set > Mode | Off/Up/Down | Off | |
| RJC > Mode | Internal/External | Internal | |
| RJC > Volt | –20000 to 20000μV | 0 | |

Environment > Operating environment

| Setup Item | Selectable Range or Selections | Default Value | Setting |
|----------------------|--|---------------|---------|
| Tag/Channel | Tag/Channel | Tag | |
| Language | English/Japanese/German/French/Chinese | English | |
| Remote Controller ID | Off/0/1/.../30/31 | Off | |
| Temperature | C/F | C | |

Environment > View, Message, Input, Alarm

| Setup Item | Selectable Range or Selections | Default Value | Setting |
|------------------------------|--------------------------------|---------------|---------|
| View > Trend type | T-Y/Circular | T-Y | |
| View > Partial | On/Off | Off | |
| View > Trend rate switching | On/Off | Off | |
| Message > Write group | Common/Separate | Common | |
| Message > Power-fail message | On/Off | Off | |
| Message > Change message | On/Off | Off | |
| Input > Value on over-range | Free/Over | Over | |
| Alarm > No logging | On/Off | Off | |

Setup Items and Default Values

Environment > Security, Media save, Batch

| Setup Item | Selectable Range or Selections | Default Value | Setting |
|--------------------------|--------------------------------|---------------|---------|
| Security > Key | Off/Login/Keylock | Off | |
| Security > Communication | Off/Login | Off | |
| Save > Auto save | On/Off | On | |
| Save > Media FIFO* | On/Off | Off | |
| Batch > On/Off | On/Off | Off | |
| Batch > Lot-No. digit | Off/4/6/8 | 6 | |
| Batch > Auto increment | On/Off | On | |

* A function available on DXs with release number 2 or later.

Environment > Service port

| Setup Item | Selectable Range or Selections | Default Value | Setting |
|------------|--------------------------------|---------------|---------|
| FTP | 1 to 65535 | 21 | |
| HTTP | 1 to 65535 | 80 | |
| SNTP | 1 to 65535 | 123 | |
| Modbus | 1 to 65535 | 502 | |

Environment > Math, Report

| Setup Item | Selectable Range or Selections | Default Value | Setting |
|--|--------------------------------|---------------|---------|
| Math > Value on Error | +Over/–Over | +Over | |
| Math > Value on Overflow > SUM, AVE | Error/Skip/Limit | Skip | |
| Math > Value on Overflow > MAX, MIN, P-P | Over/Skip | Over | |
| Report > Report select > 1 | Max/Min/Ave/Sum/Inst | Ave | |
| Report > Report select > 2 | Off/Max/Min/Ave/Sum/Inst | Max | |
| Report > Report select > 3 | Off/Max/Min/Ave/Sum/Inst | Min | |
| Report > Report select > 4 | Off/Max/Min/Ave/Sum/Inst | Sum | |
| Report > File type | Separate/Combine | Separate | |

Keylock

| Setup Item | Selectable Range or Selections | Default Value | Setting |
|---------------------------------------|--------------------------------|---------------|---------|
| Password | 8 characters or less | – | |
| Key action > START | Free/Lock | Free | |
| Key action > STOP | Free/Lock | Free | |
| Key action > MENU | Free/Lock | Free | |
| Key action > USER | Free/Lock | Free | |
| Key action > DISP/ENTER | Free/Lock | Free | |
| Key action > FAVORITE | Free/Lock | Free | |
| Media/USB > External media | Free/Lock | Free | |
| Action of Function > AlarmACK | Free/Lock | Free | |
| Action of Function > Message/Batch | Free/Lock | Free | |
| Action of Function > Math | Free/Lock | Free | |
| Action of Function > Data save | Free/Lock | Free | |
| Action of Function > E-mail/FTP | Free/Lock | Free | |
| Action of Function > Time set | Free/Lock | Free | |
| Action of Function > Display Function | Free/Lock | Free | |

Login

| Setup Item | Selectable Range or Selections | Default Value | Setting |
|---|--------------------------------|---------------|---------|
| User basic settings > Auto logout | Off/1min/2min/5min/10min | Off | |
| User basic settings > Operation without Login | Off/Display | Off | |
| Admin settings > Admin number | 1/2/3/4/5 | 1 | |
| Admin settings > Mode | Off/Key/Comm/Web/Key+Comm | Off | |
| Admin settings > User name | 20 characters or less | Admin1 etc. | |
| Admin settings > Password | 8 characters or less | ???????? | |
| User settings > User number | 1/2/3/.../29/30 | 1 | |
| User settings > Mode | Off/Key/Comm/Web/Key+Comm | Off | |
| User settings > User name | 20 characters or less | User1 etc. | |
| User settings > Password | 8 characters or less | ???????? | |
| User settings > Authority of user | Off/1/2/3/4/5/6/7/8/9/10 | Off | |
| Authority of user | | | |
| Authority of user | 1/2/3/4/5/6/7/8/9/10 | 1 | |
| Key action > START | Free/Lock | Free | |
| Key action > STOP | Free/Lock | Free | |
| Key action > MENU | Free/Lock | Free | |
| Key action > USER | Free/Lock | Free | |
| Key action > DISP/ENTER | Free/Lock | Free | |
| Key action > FAVORITE | Free/Lock | Free | |
| Media/USB > External media | Free/Lock | Free | |
| Action of Function > AlarmACK | Free/Lock | Free | |
| Action of Function > Message/Batch | Free/Lock | Free | |
| Action of Function > Math | Free/Lock | Free | |
| Action of Function > Data save | Free/Lock | Free | |
| Action of Function > E-mail/FTP | Free/Lock | Free | |
| Action of Function > Time set | Free/Lock | Free | |
| Action of Function > Display Function | Free/Lock | Free | |

Report

| Setup Item | Selectable Range or Selections | Default Value | Setting |
|---|--|----------------------|---------|
| Basic settings > Report kind | Off/Hour/Day/Hour+Day/Day+Week/Day+Month | Off | |
| Basic settings > Date | 1 to 28 | 1 | |
| Basic settings > Day of the week (Day+week) | SUN/MON/TUE/WED/THU/FRI/SAT | SUN | |
| Basic settings > Time (hour) | 0 to 23 | 0:00 | |
| Report settings > Report channel number | R01/R02/R03/.../R59/R60 | R01 | |
| Report settings > On/Off | On/Off | Depends on the model | |
| Report settings > Channel | Channel number | 1 etc. | |
| Report settings > Sum scale | Off, /s, /min, /h, /day | /s | |

Time settings

| Setup Item | Selectable Range or Selections | Default Value | Setting |
|--------------------------------------|--|---------------|---------|
| Time settings > Time zone (HHMM) | -1300 to 1300 | 900 | |
| Time settings > Time deviation limit | Off/10s/20s/30s/1min/2min/3min/4min/5min | 30s | |
| Time settings > Date format | Y/M/D, M/D/Y, D/M/Y, D.M.Y | Y/M/D | |

Load settings, Initialize

| Setup Item | Selectable Range or Selections | Default Value | Setting |
|----------------------|--------------------------------|---------------|---------|
| Load settings > Kind | CF/USB | CF | |
| Initialize > Kind | Clear 1/Clear 2/Clear 3 | Clear 3 | |
| Media eject | CF/USB | - | |

Setup Items and Default Values

Communication (Ethernet) > IP-address

| Setup Item | Selectable Range or Selections | Default Value | Setting |
|------------------------------------|--------------------------------|---------------|---------|
| DHCP | Use/Not | Not | |
| DNS accession | Use/Not | Use | |
| Host-name register | Use/Not | Use | |
| Fixed IP-address > IP-address | 0.0.0.0 to 255.255.255.255 | 0.0.0.0 | |
| Fixed IP-address > Subnet mask | 0.0.0.0 to 255.255.255.255 | 0.0.0.0 | |
| Fixed IP-address > Default gateway | 0.0.0.0 to 255.255.255.255 | 0.0.0.0 | |

Communication (Ethernet) > Host settings

| Setup Item | Selectable Range or Selections | Default Value | Setting |
|-------------|--------------------------------|---------------|---------|
| Host name | 64 characters or less | – | |
| Domain name | 64 characters or less | – | |

Communication (Ethernet) > DNS settings

| Setup Item | Selectable Range or Selections | Default Value | Setting |
|--|--------------------------------|---------------|---------|
| Server search order > Primary | 0.0.0.0 to 255.255.255.255 | 0.0.0.0 | |
| Server search order > Secondary | 0.0.0.0 to 255.255.255.255 | 0.0.0.0 | |
| Domain suffix search order > Primary | 64 characters or less | – | |
| Domain suffix search order > Secondary | 64 characters or less | – | |

Communication (Ethernet) > Keep alive, Application time out

| Setup Item | Selectable Range or Selections | Default Value | Setting |
|-------------------------------|--------------------------------|---------------|---------|
| Keep alive | On/Off | On | |
| Application time out > On/Off | On/Off | Off | |
| Application time out > Time | 1 to 120 (min) | 1 | |

Communication(Ethernet) > Server

| Setup Item | Selectable Range or Selections | Default Value | Setting |
|------------|--------------------------------|---------------|---------|
| FTP | Use/Not | Not | |
| Web | Use/Not | Use* | |
| SNTP | Use/Not | Not | |
| Modbus | Use/Not | Not | |

* A value on DXs with release number 2 or later.

Communication (Ethernet) > Web page

| Setup Item | Selectable Range or Selections | Default Value | Setting |
|---------------------------|--------------------------------|---------------|---------|
| Page type | Operator/Monitor | Operator | |
| Page type=Operator | | | |
| Web page > On/Off | On/Off | Off | |
| Web page > Access control | Off/Admin | Off | |
| Web page > Command | Use/Not | Not | |
| Page type=Monitor | | | |
| Web page > On/Off | On/Off | Off | |
| Web page > Access control | Off/Admin/User | Off | |

Communication (Ethernet) > E-Mail

| Setup Item | Selectable Range or Selections | Default Value | Setting |
|---|--------------------------------|----------------|---------|
| Basic settings | | | |
| SMTP server name | 64 characters or less | – | |
| Port number | 0 to 65535 | 25 | |
| Recipient 1 | 150 characters or less | – | |
| Recipient 2 | 150 characters or less | – | |
| Sender | 64 characters or less | – | |
| Alarm settings | | | |
| E-Mail Recipients > Recipient 1 | On/Off | Off | |
| E-Mail Recipients > Recipient 2 | On/Off | Off | |
| Active Alarms > Alarm 1 | On/Off | Off | |
| Active Alarms > Alarm 2 | On/Off | Off | |
| Active Alarms > Alarm 3 | On/Off | Off | |
| Active Alarms > Alarm 4 | On/Off | Off | |
| E-Mail Contents > Include INST | On/Off | Off | |
| E-Mail Contents > Include source URL | On/Off | Off | |
| E-Mail Contents > Subject | 32 characters or less | Alarm_summary | |
| E-Mail Contents > Header 1 | 64 characters or less | – | |
| E-Mail Contents > Header 2 | 64 characters or less | – | |
| Scheduled settings | | | |
| E-Mail Recipients and Transmission time > Recipient 1 | On/Off | Off | |
| E-Mail Recipients and Transmission time > Interval | 1h/2h/3h/4h/6h/8h/12h/24h | 24h | |
| E-Mail Recipients and Transmission time > Ref.time | 00:00 to 23:59 | 00:00 | |
| E-Mail Recipients and Transmission time > Recipient 2 | On/Off | Off | |
| E-Mail Recipients and Transmission time > Interval | 1h/2h/3h/4h/6h/8h/12h/24h | 24h | |
| E-Mail Recipients and Transmission time > Ref.time | 00:00 to 23:59 | 00:00 | |
| E-Mail Contents > Include INST | On/Off | Off | |
| E-Mail Contents > Include source URL | On/Off | Off | |
| E-Mail Contents > Subject | 32 characters or less | – | |
| E-Mail Contents > Header 1 | 64 characters or less | – | |
| E-Mail Contents > Header 2 | 64 characters or less | – | |
| System settings | | | |
| E-Mail Recipients > Recipient 1 | On/Off | Off | |
| E-Mail Recipients > Recipient 2 | On/Off | Off | |
| E-Mail Contents > Include source URL | On/Off | Off | |
| E-Mail Contents > Subject | 32 characters or less | System_warning | |
| E-Mail Contents > Header 1 | 64 characters or less | – | |
| E-Mail Contents > Header 2 | 64 characters or less | – | |
| Report settings | | | |
| E-Mail Recipients > Recipient 1 | On/Off | Off | |
| E-Mail Recipients > Recipient 2 | On/Off | Off | |
| E-Mail Contents > Include source URL | On/Off | Off | |
| E-Mail Contents > Subject | 32 characters or less | Report_data | |
| E-Mail Contents > Header 1 | 64 characters or less | – | |
| E-Mail Contents > Header 2 | 64 characters or less | – | |

Setup Items and Default Values

Communication (Ethernet) > FTP client

| Setup Item | Selectable Range or Selections | Default Value | Setting |
|-------------------------------------|--------------------------------|---------------|---------|
| FTP transfer file > Disp&Event data | On/Off | Off | |
| FTP transfer file > Report | On/Off | Off | |
| FTP transfer file > Snapshot | On/Off | Off | |
| FTP connection | Primary/Secondary | Primary | |
| FTP server name | 64 characters or less | – | |
| Port number | 0 to 65535 | 21 | |
| Login name | 32 characters or less | – | |
| Password | 32 characters or less | – | |
| Account | 32 characters or less | – | |
| PASV mode | On/Off | Off | |
| Initial path | 64 characters or less | – | |

Communication (Ethernet) > SNMP client

| Setup Item | Selectable Range or Selections | Default Value | Setting |
|---|--------------------------------|---------------|---------|
| SNMP client > Use/Not | Use/Not | Not | |
| SNMP client > Server name | 64 characters or less | – | |
| SNMP client > Port number | 0 to 65535 | 123 | |
| SNMP client > Access interval | Off/1h/8h/12h/24h | 8h | |
| SNMP client > Access reference time | 00:00 to 23:59 | 00:00 | |
| SNMP client > Access timeout | 10s/30s/90s | 30s | |
| SNMP client > Time adjust on Start action | On/Off | Off | |

Communication (Ethernet) > Modbus client

| Setup Item | Selectable Range or Selections | Default Value | Setting |
|--|--|---------------|---------|
| Basic settings > Read cycle | 125ms/250ms/500ms/1s/2s/5s/10s | 1s | |
| Basic settings > Retry interval | Off/10s/20s/30s/1min/2min/5min/10min/ 20min/30min/1h | 2min | |
| Server number | 1-8/9-16 | 1-8 | |
| Modbus server settings > Port | 0 to 65535 | 502 | |
| Modbus server settings > Modbus server name | 64 characters or less | – | |
| Modbus server settings > Unit | Auto/Fixed | Auto | |
| Modbus server settings > No. | 0 to 255 | 1 | |
| Client command number | 1-8/9-16 | 1-8 | |
| Command settings | Off/R/R-M/W/W-M | Off | |
| Command settings > Client settings > First | Depends on the command type. | – | |
| Command settings > Client settings > Last | Depends on the command type. | – | |
| Command settings > Server settings > Server | 1/2/3/.../15/16 | 1 | |
| Command settings > Server settings > Registers | Numerical value | 30001 | |
| Command settings > Server settings > Type | INT16/UINT16/INT32_B/INT32_L/UINT32_B/ UINT32_L/FLOAT_B/FLOAT_L | INT16 | |

Communication (Serial)

| Setup Item | Selectable Range or Selections | Default Value | Setting |
|--|--|---------------|---------|
| Basic settings > Baud rate | 1200/2400/4800/9600/19200/38400 | 9600 | |
| Basic settings > Data length | 7/8 | 8 | |
| Basic settings > Parity | Odd/Even/None | Even | |
| Basic settings > Handshaking | Off:Off/XON:XON/XON:RS/CS:RS | Off:Off | |
| Basic settings > Address | 1 to 99 | 1 | |
| Basic settings > Protocol | Normal/Modbus/Modbus-M | Normal | |
| Modbus master > Basic settings > Read cycle | 125ms/250ms/500ms/1s/2s/5s/10s | 1s | |
| Modbus master > Basic settings > Timeout | 125ms/250ms/500ms/1s/2s/5s/10s/1min | 1s | |
| Modbus master > Basic settings > Retrials | Off/1/2/3/4/5/10/20 | 1 | |
| Modbus master > Basic settings > Inter-block delay | Off/5ms/10ms/15ms/45ms/100ms | Off | |
| Modbus master > Basic settings > Auto recovery | Off/1min/2min/5min/10min/20min/30min/1h | 2min | |
| Master command number | 1-8/9-16 | 1-8 | |
| Command settings | Off/R/R-M/W/W-M | Off | |
| Command settings > Master > First | Depends on the command type. | – | |
| Command settings > Master > Last | Depends on the command type. | – | |
| Command settings > Slave > Address | 1 to 247 | 1 | |
| Command settings > Slave > Registers | Numerical value | 30001 | |
| Command settings > Slave > Type | INT16/UINT16/INT32_B/INT32_L/UINT32_B/ UINT32_L/FLOAT_B/FLOAT_L | INT16 | |

Status relay

| Setup Item | Selectable Range or Selections | Default Value | Setting |
|---------------------|--------------------------------|---------------|---------|
| Memory/Media status | On/Off | Off | |
| Measurement error | On/Off | Off | |
| Communication error | On/Off | Off | |
| Memory stop | On/Off | Off | |

End

| Setup Item | Selectable Range or Selections | Default Value | Setting |
|---|--------------------------------|---------------|---------|
| Do you want to store and make the new settings take effect? | Yes/No/Cancel | – | |